

CRAWLER EXCAVATOR

HX380AL



READY TO CHANGE YOUR WORLD

The HX380AL Crawler Excavator is part of Hyundai's brand new A-series:

a fresh generation of construction equipment that complies with the European Stage V emission levels. But it goes much further than that! While fulfilling regulatory demands, Hyundai aimed for a ground-breaking level of customer satisfaction with maximum performance and productivity, better safety, more convenience and improved uptime management.

From its robust exterior design to its performance-enhancing smart technologies, the HX380AL opens up a world of new possibilities where tiny efforts move mountains. It's time to experience the Hyundai Effect!



Productivity & Efficiency

POWER AND EFFICIENCY TO MAKE YOU MORE PRODUCTIVE

The HX380AL is powered by a robust Stage V-certified Cummins L9 engine with an innovative integrated after-treatment system that reduces both emissions and maintenance requirements. It delivers all the power you need to handle demanding jobs, along with fast levelling and truck loading times and excellent fuel economy.

A range of smart technologies are included for precise management of the engine output and pump flow rate. The EPIC (Electric Pump Independent Control) system improves efficiency through automated control of the individual hydraulic pumps. Additional features optimise operation and monitoring to enhance productivity every single day.

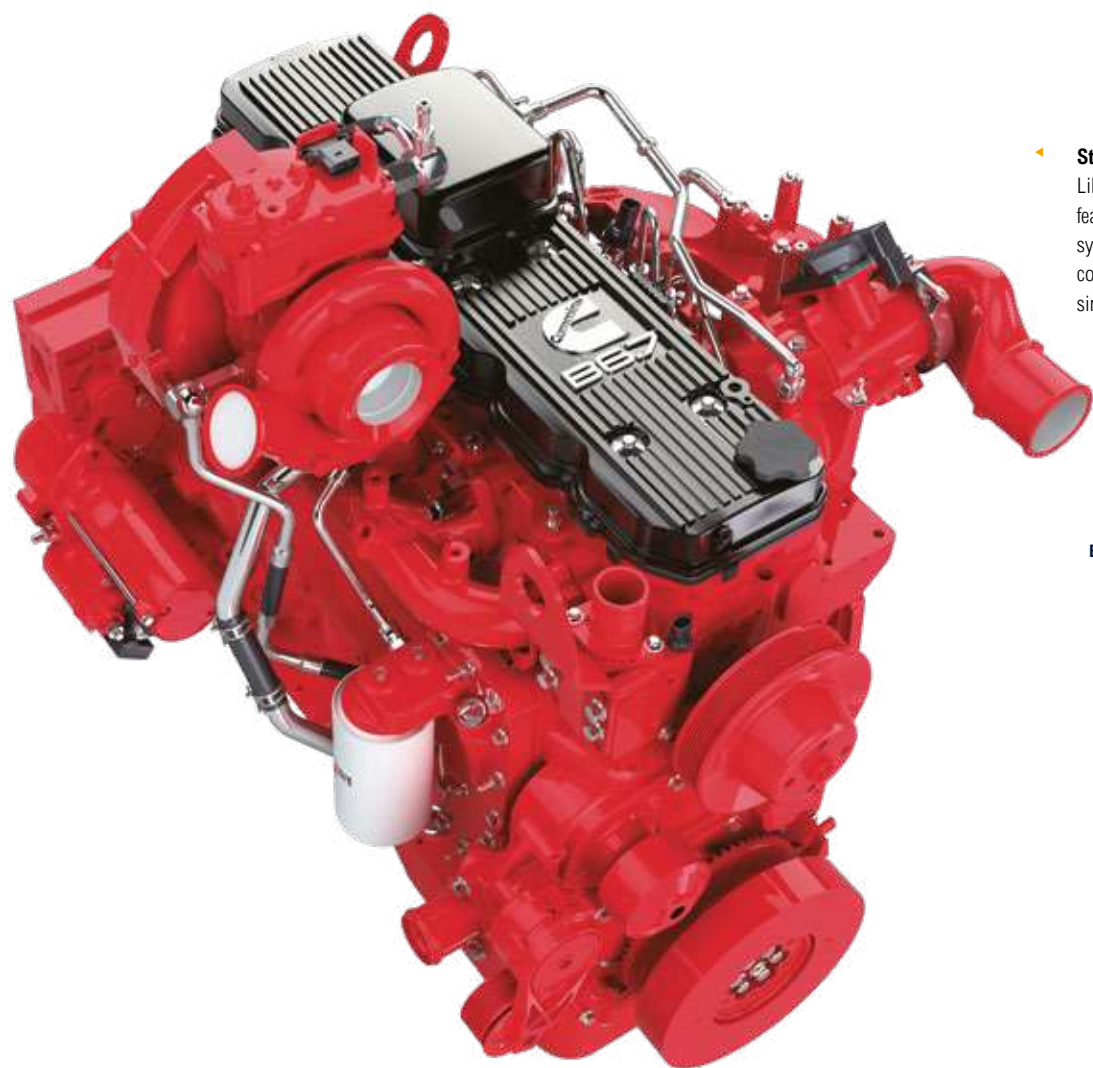

Stage V-certified engine
Like all A-Series machines, the HX380AL features our all-in-one exhaust aftertreatment system which cuts emissions and operating costs while enhancing reliability and simplifying maintenance.



“I’m saving on fuel and reducing emissions without having to compromise on productivity!”

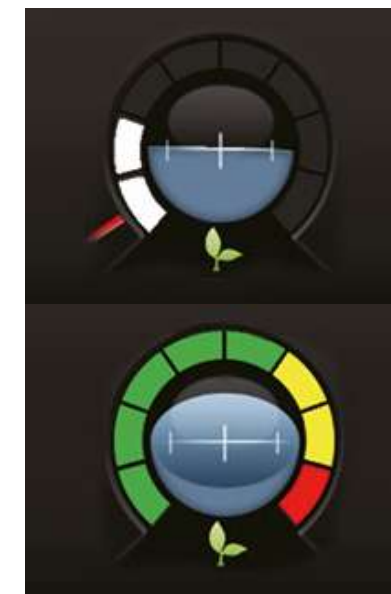

EPIC (Electric Pump Independent Control)

The HX A-Series features an improved IPC (Intelligent Power Control) system that optimises the pump flow rate and power at various working conditions through individual pump control. EPIC improves fuel efficiency while helping to reduce losses in hydraulic flow and maximise production capacity.

Eco Gauge

The gauge level adjusts according to the engine workload, while different colours provide an instant view of fuel savings during operation.

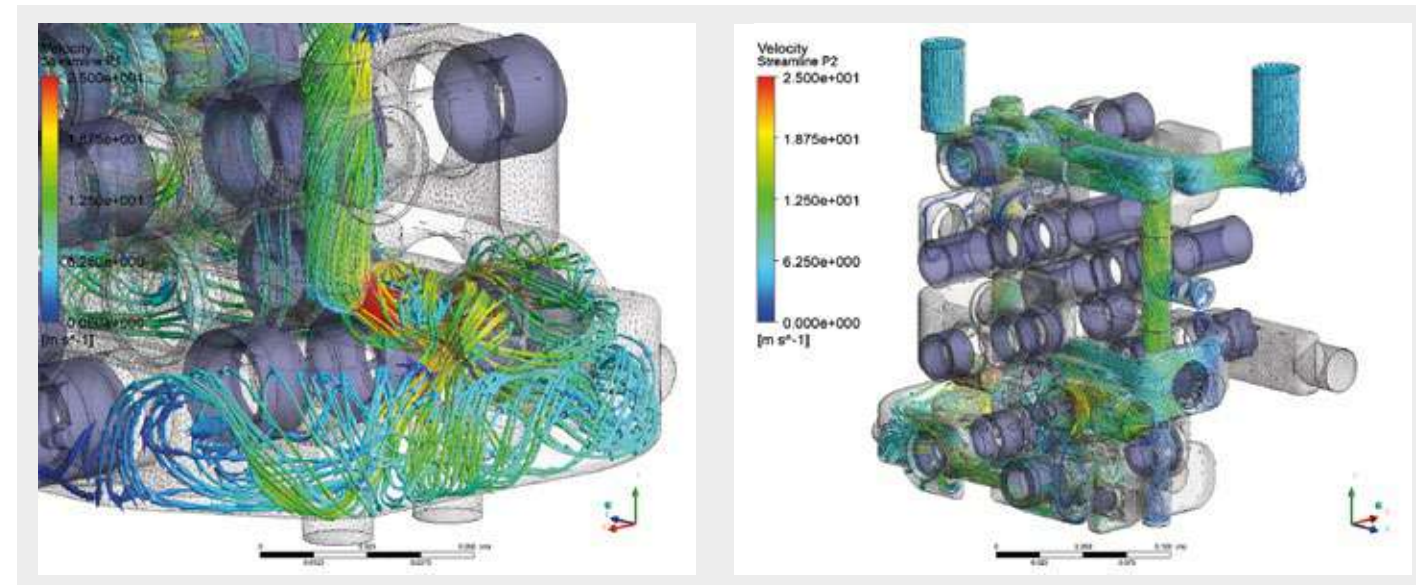

Fuel Rate Information

Average or recent fuel consumption can be displayed to guide you towards more economical operation.

Eco Report

The Eco Report feature helps you to develop efficient working habits by displaying real-time information about machine performance.

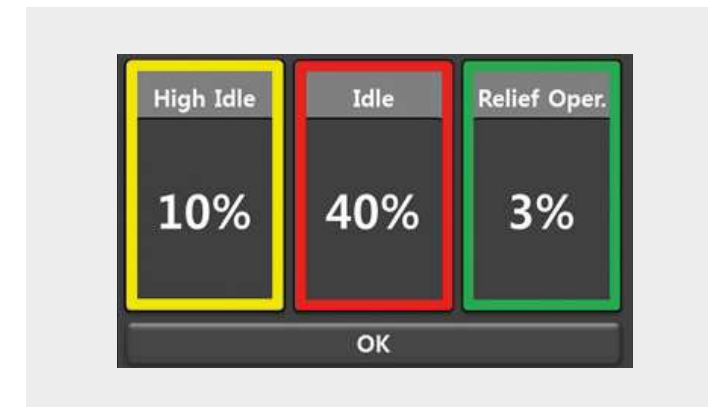

Durability

READY FOR ACTION AND BUILT TO LAST

You need to know that the investment you make today will help to sustain your business over the long term. That's why we prioritised reliability throughout the development of the HX380AL, from design and manufacturing to quality control. The upper and lower frame structures are reinforced for high load work, while the attachments have been rigorously tested for the roughest conditions. The overall aim is to minimise downtime and repairs so that you can stay on schedule, avoid unexpected costs and protect your profits.



“It’s eco-friendly, high-performing and reliable – the ideal combination for my most challenging jobs.”

Frame structures and attachments

The upper and lower frame structures have been reinforced and rigorously tested (both on the road and through virtual simulation) to ensure that they exceed on-site demands for durability. The wear resistance of the bucket has been improved through the use of new material.

Exhaust after-treatment system

The engine and exhaust after-treatment system are integrated for simplified control and maintenance.

Hydraulic hoses

High-grade hoses with outstanding resistance to heat and pressure provide maximum durability, even in rough working conditions.

Side protectors

The machine can optionally be equipped with side bumpers to absorb any impact on the exterior frame and protect the machine.

Cooling module

HX A-Series machines are enhanced with a durable cooling module that has been stringently tested to protect productivity in tough working environments.

Cabin protection

Several different types of cabin guards are available for the HX380AL, allowing you to further improve safety and durability.

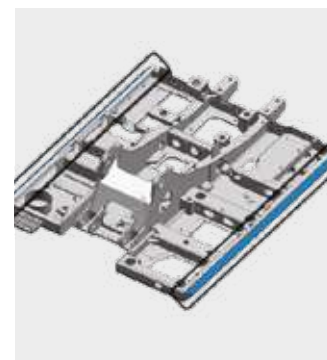
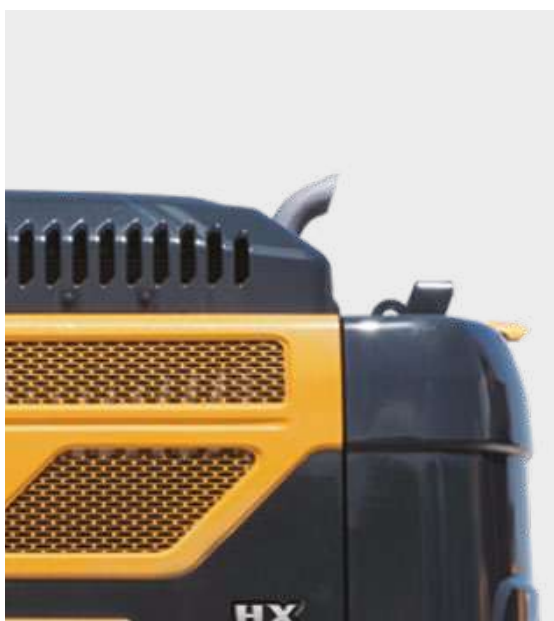
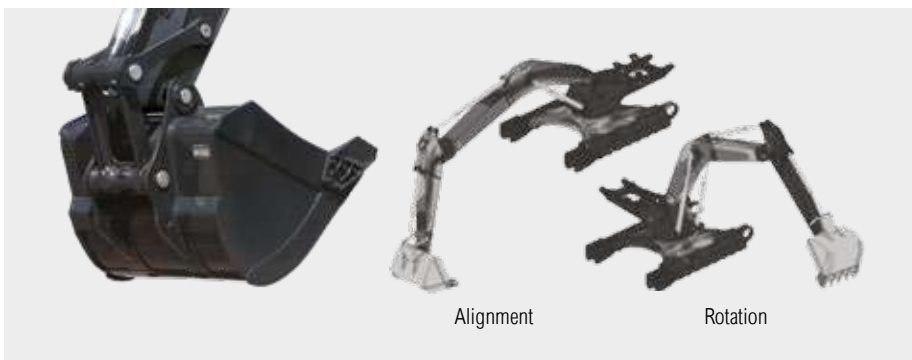

Operator Comfort

A CABIN DESIGNED AROUND YOU

The HX380AL cabin provides every operator with a comfortable working environment that boosts productivity and reduces fatigue. Designed to minimise noise and vibration, it has a high-quality, comfortable seat and centralises the most important controls within easy reach. A range of options help you to tailor the cabin to your needs, including an integrated audio system with radio, USB and AUX input to keep you entertained during your working day. The overall design places you right at the centre of the Hyundai Effect, with a world of convenience at your fingertips.



Wide touchscreen monitor

The HX380AL features an 8-inch display with a touchscreen and excellent legibility. It allows quick and easy access to machine status information at any time during operation.



Straight travel pedal (option)

The straight travel pedal option adds to comfort and convenience when travelling long distances or combining travel and attachment operation.

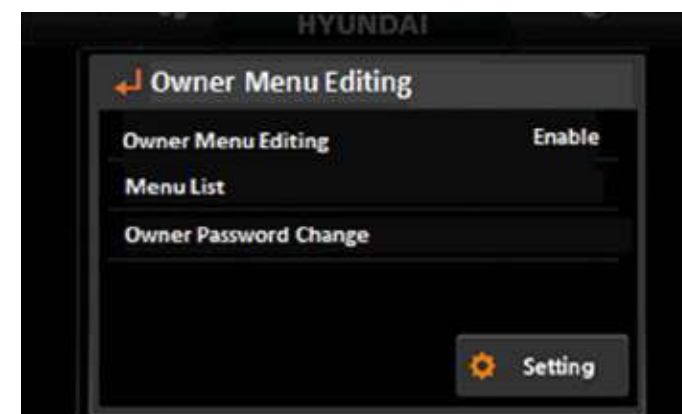

Owner Menu Editing (OME)

Menu functions can be set by the machine owner, who can also provide or restrict access for machine users by using a password to lock or unlock the list.



Air suspension seat and ergonomic joysticks

The HX380AL has a luxurious air suspension seat with heating as standard. The ergonomic joysticks make operation comfortable and intuitive.

Proportional auxiliary hydraulic controls (option)

Sensitive regulated proportional controls are available as an option. They enhance work results by enabling smooth and precise operation of hydraulic attachments via the joysticks.

Miracast connectivity

The Miracast system based on the operator's smartphone Wi-Fi allows the use of various smartphone features on the screen, including navigation, web surfing and music and video playback.



Haptic controller

The accelerator, remote air conditioner controller and instrument cluster can be operated using the convenient jog shuttle-type haptic controller.



"The cabin is a quiet and relaxing place to work. It feels as if it was tailor-made for me!"

Safety

PROTECTION FOR CO-WORKERS AND MACHINERY

Small details can make a huge difference when it comes to safety and security. The HX380AL offers all-round protection for you, your workmates and your equipment. The cabin is designed to provide maximum visibility, while Advanced Around View Monitoring (AAVM) gives you a clear overview of your surroundings. By helping to ensure an accident-free worksite, the HX380AL contributes to the peace of mind and productivity that form part of the Hyundai Effect.

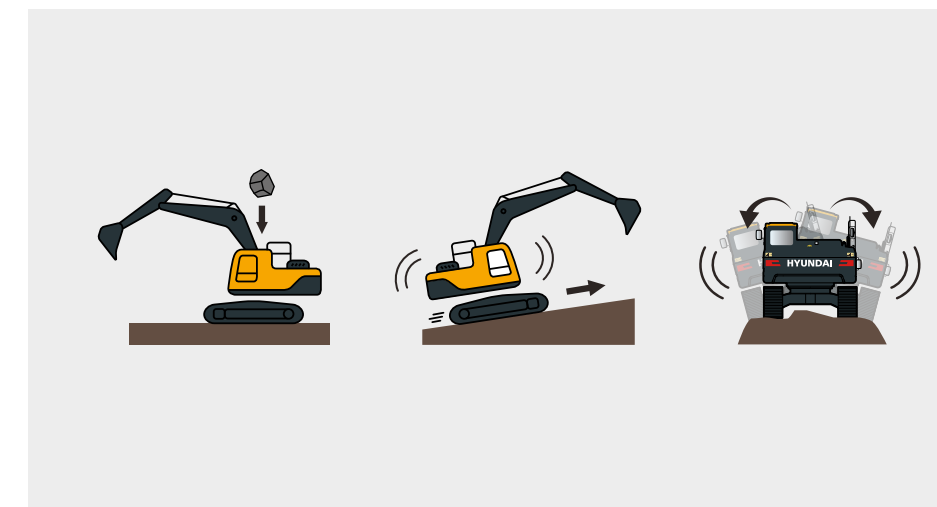

Cabin structure

The cabin structure is reinforced with integrally welded, low-stress, high-strength steel. It is certified to ISO 12117-2 (ROPS - Roll-over Protective Structures) and ISO 10262 Level 2 (FOPS - Falling Object Protective Structures) safety standards.



Advanced Around View Monitoring (AAVM)

The AAVM camera system gives you a 360° overview of your immediate working environment. It also includes Intelligent Moving Object Detection (IMOD) technology that senses and warns you when people or objects come within five metres of the machine.



Seatbelt warning alarm

Operators are reminded to fasten their safety belt by an audible and visible alarm.

“The HX380AL has lots of advanced technologies that protect machine operators and make the construction site a safer place.”

Improved visibility and safety

The open design of the cabin entrance gives the operator a clear, unimpeded view to the exterior. The door handle has also been redesigned for safer, more convenient access.

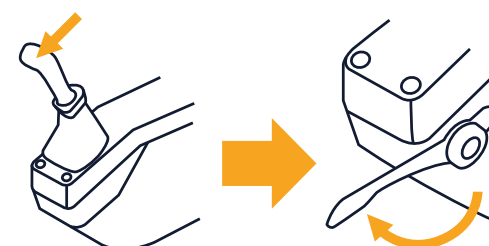

Auto safety lock

The auto safety lock feature prevents unintentional ignition. When the lock is activated, the excavator is not controlled by the RCV lever.

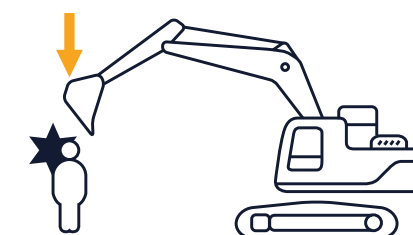

Serviceability & Connectivity

ADVANCED DIAGNOSTICS AND SERVICING SUPPORT

The peace of mind that comes with quick, low-effort servicing is also part of the Hyundai Effect. The HX380AL is designed to make maintenance as convenient as possible. All components and materials have been optimised to ensure a long, trouble-free life. Hyundai's innovative Hi MATE telematics system enables full monitoring of machine activity and performance. Maximum connectivity is integrated to help you create a smart construction site and protect your profitability.



"I have a constant overview of performance and maintenance requirements - plus advice and support whenever I need it."

HCE Diagnostic Tools (HCE-DT) app

Technicians can now connect wirelessly to the machine on-site using a smartphone or laptop. A quick check can be performed to diagnose the root cause of a failure or to troubleshoot for fault codes. The HCE-DT app retrieves machine and engine data from a combined cloud-based platform to run a failure analysis in real-time. Combined with ECD, it increases first-visit fix rates.



Passive DPF system

The passive system provides permanent regeneration of the diesel particulate filter during operation, eliminating the need for active DPF regeneration.

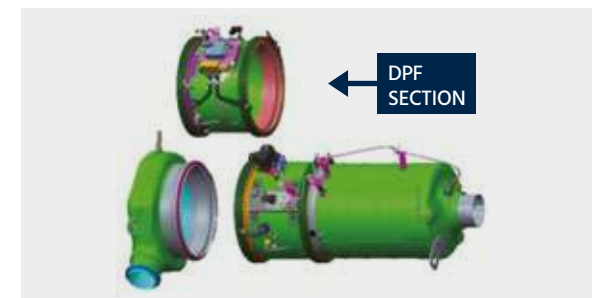

Mobile Fleet app

Hyundai's new Mobile Fleet app provides all the information you need to run your fleet efficiently and economically. Based on telematics, this advanced solution uses simple graphics and key performance data for smart fleet management.

200%
improved

Extended filter lifetime

The service intervals for the engine-oil filter and the fuel filters have been increased from 500 hours to 1,000 hours.

HiMATE

Boost efficiency and performance

For maximum convenience and security, the HX380AL features Hyundai's exclusive Hi MATE remote fleet management system, which uses mobile data technology to provide the highest level of service and support. You can monitor your equipment wherever you are via a dedicated website or mobile app, with access to working parameters like total engine hours, machine utilisation, actual performed working hours and fuel consumption and machine location.



ECD (Engine Connected Diagnostics)

ECD provides troubleshooting advice as well as tailored servicing and parts support from Cummins Quick Serve. Service technicians are supported with remote diagnostics reports allowing them to prepare for site visits and bring the right tools.

We're all connected!



Just 5 minutes



One-stop solution



Increase productivity

By providing information such as service hours, idle time and fuel consumption, Hi MATE saves you money and improves productivity. Service alerts enable better maintenance planning.



Monitor your machines

Hi MATE's real-time location information allows better, more convenient monitoring of your equipment. Just log onto the Hi MATE website or mobile app to see your machines at any time, from any location. Receive data online, by e-mail or directly on your mobile device.



Improve security

Protect your equipment from theft or unauthorised usage. Hi MATE's geofencing alerts notify you automatically when a machine leaves a predetermined zone.

Parts & Warranties

HYUNDAI GENUINE PARTS AND WARRANTIES: THE BEST WAY TO PROTECT YOUR INVESTMENT

Hyundai Genuine parts, accessories and warranty programmes are specially designed to keep your machine covered. They increase uptime and maintain the performance, comfort, and convenience that are built into your equipment.



A network you can rely on

Hyundai Construction Equipment Europe prioritises quick, reliable intervention to keep your equipment running reliably. In the 13000 m² warehouse, Hyundai covers over 96% of all Genuine Parts. With one of Europe's most advanced automated warehousing systems, we are able to maintain availability and efficient delivery of all our Genuine Parts. Moreover, we guarantee a 24-hour delivery service across our European dealer network.



Fuel filters

Hyundai fuel filters provide the right degree of filtration to keep your engine clean. They are designed to meet and exceed the engine manufacturer's prerequisites for water separation and dirt filtration, prolonging the life of your engine.



Hyundai Genuine parts

Hyundai Genuine parts have the same design as those installed when your machine left the factory. They are subjected to rigorous quality inspections and tests to make sure they meet Hyundai's strict requirements for quality and durability. As well as minimising downtime, this helps to ensure peak performance on every task.



Aftermarket kits

You can order Hyundai aftermarket kits via your dealer. This AAVM system for example, improves safety in and around your working environment at all times.



Hyundai warranties

Our warranties are also designed to give you the cover you need to build your business with confidence and peace of mind.

Standard warranties

We offer standard warranty coverages for all wheel loaders. Next to this standard coverage, optional and extended warranty periods are available, so you can benefit from full warranty coverage for longer, and even over the full lifetime of the machines. Please discuss the optimal solution for your needs with your local Hyundai dealer.

Extended warranties

Our extended warranties help you maintain full control over your operating costs. If you combine an extended warranty programme with a tailored maintenance contract, you can completely avoid unexpected costs.

Walk-around

HX380AL

Productivity & Efficiency

- Short cycle times
- Electric Pump Independent Control (EPIC)
- Customisable hydraulic attachment lines
- Attachment flow control (20 tools programmable)
- Fuel Rate Information
- ECO Gauge
- Automatic engine shutdown

Operator comfort

- Spacious cabin
- 8" touchscreen monitor
- Automatic climate control
- Smart key and start/stop button
- Air suspension seat with heater
- Viscous cab suspension mounts
- Ergonomic joystick design

Serviceability & Connectivity

- Excellent accessibility
- Centralised greasing
- Hi MATE telematic system
- Extended service intervals

OPTION

Durability & Safety

- Excellent visibility
- AAVM camera system
- LED lights
- Reinforced upper and lower structure
- High-grade hoses
- Reinforced pins, bushings and polymer shims
- Swing lock

OPTION

OPTION



READY TO CHANGE YOUR WORLD

Hyundai's crawler excavators are designed to create better conditions for operators and deliver the ultimate ownership experience. Every detail is carefully fine-tuned to match your needs in the field, including better safety and comfort, higher productivity, maximum uptime and easy servicing. It's all part of the Hyundai Effect.

Explore the range at hyundai-ce.eu



SPECIFICATIONS

ENGINE			
Maker / Model	Cummins / L9		
Type	Turbocharged, charge air cooled, diesel engine		
Rated Flywheel Horse Power	SAE	J1,995 (gross)	365 HP (272 kW) at 2,100 rpm
		J1,349 (net)	359 HP (268 kW) at 2,100 rpm
	DIN	6,271/1 (gross)	370 PS (272 kW) at 2,100 rpm
6,271/1 (net)		363 PS (272 kW) at 2,100 rpm	
Max. Power	380 HP (283 kW) at 1,800 rpm		
Max. Torque	1,795 N·m (1,324 lb-ft) at 1,400 rpm		
Piston displacement	8,900 cc (543 cu in)		

HYDRAULIC SYSTEM	
MAIN PUMP	
Type	Variable displacement tandem axis piston pumps
Max. Flow	2 x 340 lpm (89.8 U.S. gpm/74.8 U.K. gpm)
Sub-Pump For Pilot Circuit	Gear pump
Cross-sensing and fuel saving pump system.	

HYDRAULIC MOTORS	
Travel	Variable displacement axial piston motor
Swing	Axial piston motor

RELIEF VALVE SETTING	
Implement circuits	330 kgf/cm ² (4,693 psi)
Travel	360 kgf/cm ² (5,120 psi)
Power boost (boom, arm, bucket)	360 kgf/cm ² (5,120 psi)
Swing circuit	290 kgf/cm ² (4,125 psi)
Pilot circuit	40 kgf/cm ² (570 psi)
Service valve	Installed

HYDRAULIC CYLINDERS	
No. of Cylinder	Boom : Ø 160 x 1500 mm
Bore X Stroke	Arm : Ø 170 x 1760 mm
	Bucket : Ø 150 x 1295 mm

DRIVES & BRAKES	
Drive method	Fully hydrostatic type
Drive motor	Axial piston motor, in-shoe design
Reduction system	Planetary reduction gear
Max. drawbar pull	32,517 kgf (71,688 lbf)
Max. travel speed (high / low)	5.7 km/hr (3.5 mph) / 3.5 km/hr (2.2 mph)
Gradeability	35° (70%)
Parking brake	Multi wet disc

CONTROL	
Pilot pressure operated joysticks and pedals with detachable lever provide almost effortless and fatigueless operation.	
Pilot control	Two joysticks with one safety lever (LH): Swing and arm, Boom and bucket
Traveling and steering	Two levers with pedals
Engine throttle	Electric, Dial type

SWING SYSTEM	
Swing motor	Fixed displacement axial piston motor
Swing reduction	Planetary gear reduction
Swing bearing lubrication	Grease-bathed
Swing brake	Multi wet disc
Swing speed	10.4 rpm

COOLANT & LUBRICANT CAPACITY			
	liter	US gal	UK gal
Fuel tank	600	154.7	131.9
Engine coolant	42	11.1	9.3
Engine oil	30	6.4	5.4
Swing device	11	2.9	2.4
Final drive (each)	7.8	2.06	1.72
Hydraulic system (including tank)	414	106.7	91.06
Hydraulic tank	210	54.1	46.2
DEF / AdBlue®	70	18.5	15.5

UNDERCARRIAGE	
The X-leg type center frame is integrally welded with reinforced box-section track frames. The undercarriage includes lubricated rollers, idlers, track adjusters with shock absorbing springs and sprockets and a track chain with double or triple grouser shoes.	
Center frame	X - leg type
Track frame	Pentagonal box type
No. of shoes on each side	48 EA
No. of carrier roller on each side	2 EA
No. of track roller on each side	9 EA
No. of rail guard on each side	2 EA

OPERATING WEIGHT (APPROXIMATE)				
Operating weight, including 6,500 mm (21' 4") boom; 3,200 mm (10' 6") arm; SAE heaped 1.62 m ³ (2.12 yd ³) bucket, lubricant, coolant, full fuel tank, full hydraulic tank and all standard equipments.				
Shoes		Operating weight	Ground pressure	
Type	Width mm (in)	kg (lb)	kgf/cm ² (psi)	
Triple grouser	600 (24")	HX380AL	39,100 (86,200)	0.70 (9.97)
		NL	38,890 (85,737)	0.70 (9.92)
	700 (28")	HX380AL	39,550 (87,193)	0.61 (8.64)
	800 (32")	HX380AL	40,000 (88,185)	0.54 (7.65)
Double grouser	900 (36")	HX380AL	40,460 (89,199)	0.48 (6.88)
	600 (24")	HX380AL	39,520 (87,127)	0.71 (10.07)

AIR CONDITIONING SYSTEM	
The air condition system for the machine contains the fluorinated greenhouse gas with global warming potential of R134a. (Global Warming Potential : 1.430) The system hold 0.8 kg refrigerant consisting of a CO ₂ equivalent of 1.14 metric tonnes. For more information, Please refer to the manual.	

DIMENSIONS & WORKING RANGE

HX380AL / HX380A NL DIMENSIONS

6.15 m (20' 2") / 6.5 m (21' 4"), BOOM and 2.5 m (8' 2"), 3.2 m (10' 6"), 3.9 m (12' 10") ARM

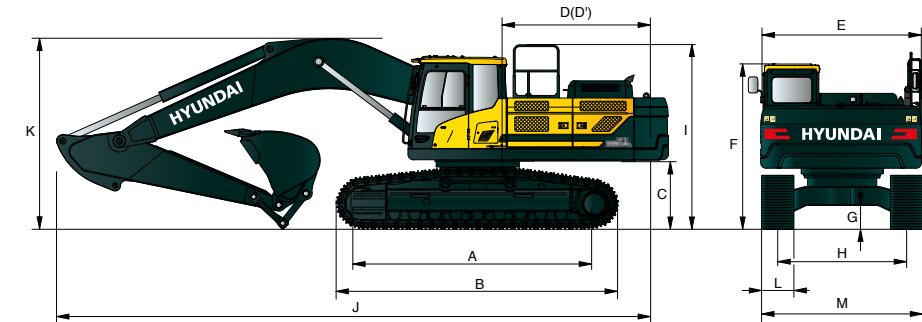

Unit : mm (ft-in)

A	Tumbler distance	4,340 (14' 3")					
B	Overall length of crawler	5,270 (17' 3")					
C	Ground clearance of counterweight	1,295 (4' 3")					
D	Tail swing radius	3,620 (11' 11")					
D'	Rear-end length	3,555 (11' 8")					
E	Overall width of upperstructure	2,980 (9' 9")					
F	Overall height of cabin	3,240 (10' 8")					
G	Min. ground clearance	550 (1' 10")					
H	Track gauge	HX380AL	2,740 (9' 0")				
		HX380A NL	2,390 (7' 10")				
I	Overall height of guardrail	3,470 (11' 5")					
		Boom length	6,150 (20' 2")	6,500 (21' 4")			
		Arm length	2,500 (8' 2")	2,500 (8' 2")	3,200 (10' 6")	3,900 (12' 10")	
J	Overall length	11,100 (36' 5")	11,450 (37' 7")	11,400 (37' 5")	11,400 (37' 5")		
K	Overall height of boom	3,830 (12' 7")	3,740 (12' 3")	3,630 (11' 11")	3,740 (12' 3")		
L	Track shoe	Type	Triple grouser				Double grouser
		width	600 (2' 0")	600 (1' 12")	700 (2' 4")	800 (2' 7")	900 (2' 11")
M	Overall width w/o additional foot board	HX380AL	3,340 (10' 11")	3,340 (10' 11")	3,440 (11' 3")	3,540 (11' 7")	3,640 (11' 11")
		HX380A NL	2,990 (9' 10")	2,990 (9' 10")	-	-	-

HX380AL / HX380A NL WORKING RANGE

Unit : mm (ft-in)

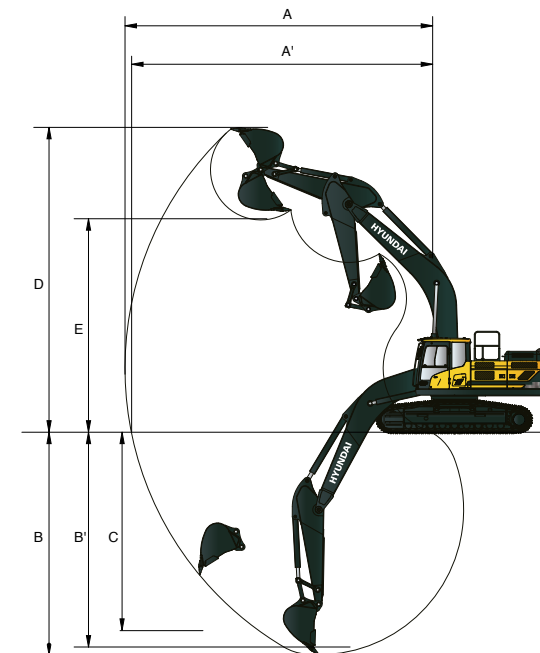

		Boom length	6,150 (20' 2")	6,500 (21' 4")		
		Arm length	2,500 (8' 2")	2,500 (8' 2")	3,200 (10' 6")	3,900 (12' 10")
A	Max. digging reach	10,300 (33' 10")	10,650 (34' 11")	11,160 (36' 7")	11,820 (38' 9")	
A'	Max. digging reach on ground	10,060 (33' 0")	10,410 (34' 2")	10,930 (35' 10")	11,620 (38' 1")	
B	Max. digging depth	6,560 (21' 2")	6,820 (22' 5")	7,520 (24' 8")	8,220 (27' 0")	
B'	Max. digging depth (8' level)	6,380 (20' 11")	6,640 (21' 9")	7,360 (24' 2")	8,080 (26' 6")	
C	Max. vertical wall digging depth	4,780 (15' 8")	5,030 (16' 6")	5,480 (28' 0")	6,300 (20' 8")	
D	Max. digging height	10,000 (32' 10")	10,330 (33' 11")	10,270 (33' 8")	10,610 (34' 10")	
E	Max. dumping height	6,870 (22' 6")	7,190 (23' 7")	7,190 (23' 7")	7,500 (24' 7")	
F	Min. front swing radius	4,310 (14' 2")	4,490 (14' 9")	4,490 (14' 9")	4,350 (14' 3")	

BUCKET SELECTION GUIDE & DIGGING FORCE

BUCKETS

All buckets are welded with high-strength steel.

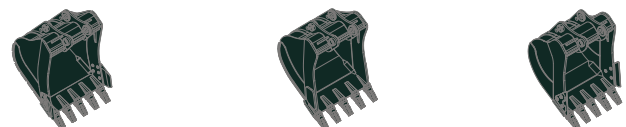

SAE heaped m ³ (yd ³)	GP	HD	Rock-HD
	1.46	1.46	1.46
	1.62	1.62	1.62
	1.90	1.90	1.90
	2.10	2.10	1.90
	2.32		

Capacity m ³ (yd ³)		Width mm (in)	Weight kg (lb)	Tooth EA	Recommendation mm (ft.in)				
SAE heaped	CECE heaped				6,250 (20' 6") Boom		6,500 (21' 4") Boom		
					2,500 (8' 2") Arm	2,500 (8' 2") Arm	3,200 (10' 6") Arm	3,900 (12' 10") Arm	
◆	1.46 (1.91)	1.28 (1.67)	1,305 (51.4")	1,400 (3,090)	4	●	●	●	●
◆	1.62 (2.12)	1.42 (1.86)	1,415 (55.7")	1,500 (3,310)	5	●	●	●	○
◆	1.90 (2.49)	1.65 (2.16)	1,600 (63.0")	1,610 (3,550)	5	●	●	○	■
◆	2.10 (2.75)	1.84 (2.41)	1,735 (68.3")	1,690 (3,730)	5	●	○	■	▲
◆	2.32 (3.03)	2.02 (2.64)	1,885 (74.2")	1,800 (3,970)	6	○	■	■	▲
■	1.46 (1.91)	1.28 (1.67)	1,305 (51.4")	1,560 (3,440)	4	●	●	●	●
■	1.62 (2.12)	1.42 (1.86)	1,415 (55.7")	1,660 (3,660)	5	●	●	●	○
■	1.90 (2.49)	1.65 (2.16)	1,600 (63.0")	1,790 (3,950)	5	●	●	○	■
■	2.10 (2.75)	1.84 (2.41)	1,735 (68.3")	1,880 (4,140)	5	○	○	■	▲
★	1.46 (1.91)	1.28 (1.67)	1,305 (51.4")	1,750 (3,860)	4	●	●	●	○
★	1.62 (2.12)	1.42 (1.86)	1,415 (55.7")	1,850 (4,080)	5	●	●	●	○
★	1.90 (2.49)	1.65 (2.16)	1,600 (63.0")	1,990 (4,390)	6	●	○	■	■

- ◆ General Purpose
- Rock-Heavy duty bucket
- ★ Heavy duty bucket
- : Applicable for materials with density of 2,100 kgf/m³ (3,500 lbf/yd³) or less
- : Applicable for materials with density of 1,800 kgf/m³ (3,000 lbf/yd³) or less
- : Applicable for materials with density of 1,500 kgf/m³ (2,500 lbf/yd³) or less
- ▲ : Applicable for materials with density of 1,200 kgf/m³ (2,000 lbf/yd³) or less

ATTACHMENT

Booms and arms are welded with a low-stress, full-box section design. 6,150 mm (20' 2"), 6,500 mm (21' 4") Booms and 2,500 mm (8' 2"), 3,200 mm (10' 6"), 3,900 mm (12' 10") Arms are available. Hyundai Bucket are all-welded, high-strength steel implements.

DIGGING FORCE

Boom	Length	mm (ft.in)	6,150 (20' 2")		6,500 (21' 4")		Remark
	Weight	kg (lb)	3,750 (8,270)	3,750 (8,270)	3,850 (8,490)	3,850 (8,490)	
Arm	Length	mm (ft.in)	2,500 (8' 2")	2,500 (8' 2")	3,200 (10' 6")	3,900 (12' 10")	
	Weight	kg (lb)	1,960 (4,320)	1,960 (4,320)	2,120 (4,670)	2,190 (4,830)	
Bucket digging force	SAE	kN	228.5 [249.3]	201.0 [219.3]	201.0 [219.3]	201.0 [219.3]	[]: Power Boost
		kgf	23,300 [25,420]	20,500 [22,360]	20,500 [22,360]	20,500 [22,360]	
	lbf	51,370 [56,040]	45,190 [49,300]	45,190 [49,300]	45,190 [49,300]		
	ISO	kN	259.9 [283.5]	228.5 [249.3]	228.5 [249.3]	228.5 [249.3]	
Arm crowd force	SAE	kgf	26,500 [28,910]	23,300 [25,420]	23,300 [25,420]	23,300 [25,420]	
		lbf	28,420 [63,740]	51,370 [56,040]	51,370 [56,040]	51,370 [56,040]	
	kN	192.2 [209.7]	192.2 [209.7]	160.8 [175.4]	137.3 [149.7]		
	kgf	19,600 [2,1380]	19,600 [21,380]	16,400 [17,890]	14,000 [15,270]		
	lbf	43,210 [47,130]	43,210 [47,130]	36,160 [39,440]	30,860 [33,660]		
	ISO	kN	200.1 [218.2]	200.1 [218.2]	165.7 [180.8]	141.2 [154.1]	
	kgf	20,400 [22,250]	20,400 [22,250]	16,900 [18,440]	14,400 [15,710]		
	lbf	44,970 [49,050]	44,970 [49,050]	37,260 [40,650]	31,750 [34,630]		

Note : Boom weight includes arm cylinder, piping, and pin Arm weight includes bucket cylinder, linkage, and pin

LIFTING CAPACITY

Rating over-front Rating over-side or 360 degrees

HX380AL

6.15 m (20' 2") boom; 2.5 m (8' 2") arm equipped with 600 mm (24") triple grouser shoes.

Lift-point height m (ft)	Load radius								At max. Reach			
	3.0 m (9.8 ft)		4.5 m (14.8 ft)		6.0 m (19.7 ft)		7.5 m (24.6 ft)		Capacity	Reach		
											m (ft)	
7.5 m (24.6 ft)	kg				*9,240	*9,240			*9,470	*9,470	6.71	
	lb				*20,370	*20,370			*20,880	*20,880	(22.0)	
6.0 m (19.7 ft)	kg				*9,720	*9,720	*9,360	7,940	*9,400	7,600	7.69	
	lb				*21,430	*21,430	*20,640	17,500	*20,720	16,760	(25.2)	
4.5 m (14.8 ft)	kg		*14,000	*14,000	*11,060	10,960	*9,770	*9,770	*9,770	6,610	8.27	
	lb		*30,860	*30,860	*24,380	24,160	*21,540	17,110	*21,010	14,570	(27.1)	
3.0 m (9.8 ft)	kg				*10,270	10,380	*10,540	7,500	*9,770	6,130	8.55	
	lb				*22,840	22,880	*23,240	16,530	*21,540	13,510	(28.1)	
1.5 m (4.9 ft)	kg				*14,120	9,910	*11,290	7,250	9,800	6,000	8.56	
	lb				*31,130	21,850	*24,890	15,980	21,610	13,230	(28.1)	
Ground Line	kg		*20,360	14,680	*14,840	9,650	*11,690	7,090	10,180	6,200	8.29	
	lb		*44,890	32,360	*32,720	21,270	*25,770	15,630	22,440	13,670	(27.2)	
-1.5 m (-4.9 ft)	kg	*14,540	*14,540	*19,660	14,710	*14,710	9,590	*11,390	7,090	*11,910	6,830	7.72
	lb	*32,060	*32,060	*43,340	32,430	*32,430	21,140	*25,110	15,630	*24,050	15,060	(25.3)
-3.0 m (-9.8 ft)	kg	*24,010	*24,010	*17,760	14,950	*13,350	9,750		*11,280	8,310	6.77	
	lb	*52,930	*52,930	*39,150	32,960	*29,430	21,500		*24,870	18,320	(22.2)	
-4.5 m (-14.8 ft)	kg			*13,520	*13,520				*11,150	*11,150	5.23	
	lb			*29,810	*29,810				*24,580	*24,580	(17.2)	

6.5 m (21' 4") boom, 2.5 m (8' 2") arm equipped with 600 mm (24") triple grouser shoe.

Lift-point height m (ft)	Lift-point radius								At max. Reach		
	3.0 m (10 ft)		4.5 m (15 ft)		6.0 m (20 ft)		7.5 m (25 ft)		Capacity	Reach	
											m (ft)
7.5 m (24.6 ft)	kg								*8,970	8,610	7.16
	lb								*19,780	18,980	(23.5)
6.0 m (19.7 ft)	kg					*9,570	*9,570	*8,920	7,920	*8,920	8.08
	lb					*21,100	*21,100	*19,670	17,460	*19,670	(26.5)
4.5 m (14.8 ft)	kg		*14,460	*14,460	*11,020	10,780	*9,500	7,680	*9,030	6,110	8.64
	lb		*31,880	*31,880	*24,290	23,770	*20,940	16,930	*19,910	13,470	(28.3)
3.0 m (9.8 ft)	kg				*12,690	10,160	*10,330	7,380	*9,240	5,680	8.91
	lb				*27,980	22,400	*22,770	16,270	*20,370	12,520	(29.2)
1.5 m (4.9 ft)	kg				*14,020	9,690	*11,090	7,110	9,120	5,560	8.91
	lb				*30,910	21,360	*24,450	15,670	20,110	12,260	(29.2)
Ground Line	kg		*14,720	14,400	*14,660	9,450	*11,510	6,950	9,450	5,730	8.66
	lb		*32,450	31,750	*32,320	20,830	*25,380	15,320	20,830	12,630	(28.4)
-1.5 m (-4.9 ft)	kg	*19,240	14,470	*14,510	9,400	*11,360	6,920	*10,230	6,260	*10,230	8.12
	lb	*42,420	31,900	*31,990	20,720	*25,040	15,260	*22,550	13,800	*22,550	(26.6)
-3.0 m (-9.8 ft)	kg	*22,870	*22,870	*17,520	14,710	*13,390	9,540		*10,550	7,460	7.22
	lb	*50,420	*50,420	*38,620	32,430	*29,520	21,030		*23,260	16,450	(23.7)
-4.5 m (-14.8 ft)	kg			*14,070	*14,070				*10,500	10,480	5.80
	lb			*31,020	*31,020				*23,150	23,100	(19.0)

- Lifting capacity is based on ISO 10567.
- Lifting capacity of HX Series does not exceed 75% of tipping load with the machine on firm, level ground or 87% of full hydraulic capacity.
- The Lift-point is bucket pivot mounting pin on the arm (without bucket mass).
- (*) indicates load limited by hydraulic capacity.

LIFTING CAPACITY

Rating over-front Rating over-side or 360 degrees

HX380AL

6.5 m (21' 4") boom, 3.2 m (10' 6") arm equipped with 600 mm (24") triple grouser shoe.

Lift-point height m (ft)	Lift-point radius												At max. Reach			
	1.5 m (4.9 ft)		3.0 m (9.8 ft)		4.5 m (14.8 ft)		6.0 m (19.7 ft)		7.5 m (24.6 ft)		9.0 m (29.5 ft)		Capacity		Reach	
															m (ft)	
7.5 m (24.6 ft)	kg															
	lb															
6.0 m (19.7 ft)	kg															
	lb															
4.5 m (14.8 ft)	kg															
	lb															
3.0 m (9.8 ft)	kg															
	lb															
1.5 m (4.9 ft)	kg															
	lb															
Ground Line	kg															
	lb															
-1.5 m (-4.9 ft)	kg															
	lb															
-3.0 m (-9.8 ft)	kg															
	lb															
-4.5 m (-14.8 ft)	kg															
	lb															

6.5 m (21' 4") boom, 3.9 m (12' 10") arm equipped with 600 mm (24") triple grouser shoe.

Lift-point height m (ft)	Lift-point radius												At max. Reach			
	1.5 m (4.9 ft)		3.0 m (9.8 ft)		4.5 m (14.8 ft)		6.0 m (19.7 ft)		7.5 m (24.6 ft)		9.0 m (29.5 ft)		Capacity		Reach	
															m (ft)	
9.0 m (29.5 ft)	kg															
	lb															
7.5 m (24.6 ft)	kg															
	lb															
6.0 m (19.7 ft)	kg															
	lb															
4.5 m (14.8 ft)	kg															
	lb															
3.0 m (9.8 ft)	kg															
	lb															
1.5 m (4.9 ft)	kg															
	lb															
Ground Line	kg															
	lb															
-1.5 m (-4.9 ft)	kg															
	lb															
-3.0 m (-9.8 ft)	kg															
	lb															
-4.5 m (-14.8 ft)	kg															
	lb															
-6.0 m (-19.7 ft)	kg															
	lb															

- Lifting capacity is based on ISO 10567.
- Lifting capacity of HX Series does not exceed 75% of tipping load with the machine on firm, level ground or 87% of full hydraulic capacity.
- The Lift-point is bucket pivot mounting pin on the arm (without bucket mass).
- (*) indicates load limited by hydraulic capacity.

LIFTING CAPACITY

Rating over-front Rating over-side or 360 degrees

HX380A NL

6.5 m (21' 4") boom, 2.5 m (8' 2") arm equipped with 600 mm (24") triple grouser shoe.

Lift-point height m (ft)	Load radius								At max. Reach			
	3.0 m (9.8 ft)		4.5 m (14.8 ft)		6.0 m (19.7 ft)		7.5 m (24.6 ft)		Capacity		Reach	
											m (ft)	
7.5 m (24.6 ft)	kg											
	lb											
6.0 m (19.7 ft)	kg											
	lb											
4.5 m (14.8 ft)	kg											
	lb											
3.0 m (9.8 ft)	kg											
	lb											
1.5 m (4.9 ft)	kg											
	lb											
Ground Line	kg											
	lb											
-1.5 m (-4.9 ft)	kg											
	lb											
-3.0 m (-9.8 ft)	kg											
	lb											
-4.5 m (-14.8 ft)	kg											
	lb											

6.5 m (21' 4") boom, 3.2 m (10' 6") arm equipped with 600 mm (24") triple grouser shoe.

Lift-point height m (ft)	Lift-point radius												At max. Reach			
	1.5 m (4.9 ft)		3.0 m (9.8 ft)		4.5 m (14.8 ft)		6.0 m (19.7 ft)		7.5 m (24.6 ft)		9.0 m (29.5 ft)		Capacity		Reach	
															m (ft)	
7.5 m (24.6 ft)	kg															
	lb															
6.0 m (19.7 ft)	kg															
	lb															
4.5 m (14.8 ft)	kg															
	lb															
3.0 m (9.8 ft)	kg															
	lb															
1.5 m (4.9 ft)	kg															
	lb															
Ground Line	kg															
	lb															
-1.5 m (-4.9 ft)	kg															
	lb															
-3.0 m (-9.8 ft)	kg															
	lb															
-4.5 m (-14.8 ft)	kg															
	lb															

- Lifting capacity is based on ISO 10567.
- Lifting capacity of HX Series does not exceed 75% of tipping load with the machine on firm, level ground or 87% of full hydraulic capacity.
- The Lift-point is bucket pivot mounting pin on the arm (without bucket mass).
- (*) indicates load limited by hydraulic capacity.

LIFTING CAPACITY

Rating over-front Rating over-side or 360 degrees

HX380A NL

6.5 m (21' 4") boom, 3.9 m (12' 10") arm equipped with 600 mm (24") triple grouser shoe.

Lift-point height m (ft)	Lift-point radius										At max. Reach					
	1.5 m (4.9 ft)		3.0 m (9.8 ft)		4.5 m (14.8 ft)		6.0 m (19.7 ft)		7.5 m (24.6 ft)		9.0 m (29.5 ft)		Capacity	Reach		
													kg (lb)	m (ft)		
9.0 m (29.5 ft)	kg												*5,580	*5,580	7.43	
	lb												*12,300	*12,300	(24.4)	
7.5 m (24.6 ft)	kg								*6,800	*6,800			*5,240	*5,240	8.59	
	lb								*14,990	*14,990			*11,550	*11,550	(28.2)	
6.0 m (19.7 ft)	kg								*7,180	*7,180	*6,500	5,220	*5,130	4,830	9.36	
	lb								*15,830	*15,830	*14,330	11,510	*11,310	10,650	(30.7)	
4.5 m (14.8 ft)	kg							*8,930	*8,930	*7,990	6,890	*7,510	5,090	*5,200	4,320	9.85
	lb							*19,690	*19,690	*17,610	15,190	*16,560	11,220	*11,460	9,520	(32.3)
3.0 m (9.8 ft)	kg					*14,540	13,890	*10,830	9,120	*9,040	6,540	*8,060	4,900	*5,420	4,030	10.08
	lb					*32,060	30,620	*23,880	20,110	*19,930	14,420	*17,770	10,800	*11,950	8,880	(33.1)
1.5 m (4.9 ft)	kg					*17,770	12,700	*12,620	8,500	*10,080	6,190	*8,650	4,710	*5,810	3,920	10.09
	lb					*39,180	28,000	*27,820	18,740	*22,220	13,650	*19,070	10,380	*12,810	8,640	(33.1)
Ground Line	kg			*7,060	*7,060	*19,500	12,070	*13,900	8,070	*10,910	5,920	8,780	4,550	*6,450	3,970	9.87
	lb			*15,560	*15,560	*42,990	26,610	*30,640	17,790	*24,050	13,050	19,360	10,030	*14,220	8,750	(32.4)
-1.5 m (-4.9 ft)	kg	*7,760	*7,760	*11,450	*11,450	*19,920	11,850	*14,490	7,850	*11,330	5,760	8,700	4,480	*7,490	4,220	9.39
	lb	*17,110	*17,110	*25,240	*25,240	*43,920	26,120	*31,940	17,310	*24,980	12,700	19,180	9,880	*16,510	9,300	(30.8)
-3.0 m (-9.8 ft)	kg	*12,390	*12,390	*16,990	*16,990	*19,280	11,880	*14,310	7,810	*11,160	5,740			9,270	4,770	8.63
	lb	*27,320	*27,320	*37,460	*37,460	*42,510	26,190	*31,550	17,220	*24,600	12,650			20,440	10,520	(28.3)
-4.5 m (-14.8 ft)	kg	*17,960	*17,960	*24,770	*24,770	*23,970	12,130	*17,460	7,960	*13,090				*9,810	5,910	7.50
	lb	*39,590	*39,590	*54,610	*54,610	*52,840	26,740	*38,490	17,550					*21,630	13,030	(24.6)
-6.0 m (-19.7 ft)	kg			*18,940	*18,940	*13,630	12,670							*10,220	8,900	5.76
	lb			*41,760	*41,760	*30,050	27,930							*22,530	19,620	(18.9)

6.5 m (21' 4") boom, 3.9 m (12' 10") arm equipped with 600 mm (24") triple grouser shoe.

Lift-point height m (ft)	Lift-point radius								At max. Reach			
	3.0 m (9.8 ft)		4.5 m (14.8 ft)		6.0 m (19.7 ft)		7.5 m (24.6 ft)		Capacity	Reach		
									kg (lb)	m (ft)		
7.5 m (24.6 ft)	kg					*9,240	*9,240			*9,470	8,350	6.71
	lb					*20,370	*20,370			*20,880	18,410	(22.0)
6.0 m (19.7 ft)	kg					*9,720	*9,720	*9,360	6,890	*9,400	6,590	7.69
	lb					*21,430	*21,430	*20,640	15,190	*20,720	14,530	(25.2)
4.5 m (14.8 ft)	kg			*14,000	*14,000	*11,060	9,460	*9,770	6,720	*9,530	5,710	8.27
	lb			*30,860	*30,860	*24,380	20,860	*21,540	14,820	*21,010	12,590	(27.1)
3.0 m (9.8 ft)	kg					*12,720	8,900	*10,540	6,460	*9,770	5,280	8.55
	lb					*28,040	19,620	*23,240	14,240	*21,540	11,640	(28.1)
1.5 m (4.9 ft)	kg					*14,120	8,450	*11,290	6,220	9,720	5,150	8.56
	lb					*31,130	18,630	*24,890	13,710	21,430	11,350	(28.1)
Ground Line	kg			*20,360	12,280	*14,840	8,200	*11,690	6,070	10,100	5,310	8.29
	lb			*44,890	27,070	*32,720	18,080	*25,770	13,380	22,270	11,710	(27.2)
-1.5 m (-4.9 ft)	kg	*14,540	*14,540	*19,660	12,310	*14,710	8,150	*11,390	6,060	*10,910	5,850	7.72
	lb	*32,060	*32,060	*43,340	27,140	*32,430	17,970	*25,110	13,360	*24,050	12,900	(25.3)
-3.0 m (-9.8 ft)	kg	*24,010	*24,010	*17,760	12,540	*13,350	8,300			*11,280	7,110	6.77
	lb	*52,930	*52,930	*39,150	27,650	*29,430	18,300			*24,870	15,670	(22.2)
-4.5 m (-14.8 ft)	kg			*13,520	13,080					*11,150	10,580	5.23
	lb			*29,810	28,840					*24,580	23,320	(17.2)

- Lifting capacity is based on ISO 10567.
- Lifting capacity of HX Series does not exceed 75% of tipping load with the machine on firm, level ground or 87% of full hydraulic capacity.
- The Lift-point is bucket pivot mounting pin on the arm (without bucket mass).
- (*) indicates load limited by hydraulic capacity.

STANDARD/OPTIONAL EQUIPMENT

ENGINE	STD
Cummins L9 Engine	•

HYDRAULIC SYSTEM	STD
ELECTRONIC PUMP INDEPENDENT CONTROL	
3-Power Mode, 2-Work Mode, User Mode	•
Variable Power Control	•
Pump Flow Control	•
Attachment Mode Flow Control	•
Engine Auto Idle	•
Engine Auto Shutdown Control	•
Electronic Fan Control	•

CABIN & INTERIOR	STD
ISO STANDARD CABIN	
Rise-Up Type Windshield Wiper	•
Radio / USB Player	•
Handsfree Mobile Phone System with USB	•
12 V Power Outlet (24 V DC to 12 V DC Converter)	•
Electric Horn	•
All-Weather Steel Cab with 360° Visibility	•
Safety Glass Windows	•
Sliding Fold-In Front Window	•
Sliding Side Window (LH)	•
Lockable Door	•
Hot & Cool Box	•
Storage Compartment	•
Ashtray	•
Transparent Cabin Roof-Cover	•
Sun Visor	•
Door and Cabin Locks, One Key	•
Pilot-Operated Slidable Joystick	•
Console Box Height Adjust System	•
Smart key with start/stop button	•

AUTOMATIC CLIMATE CONTROL	STD
Air Conditioner & Heater	•
Defroster	•
Starting Aid (Air Grid Heater) for Cold Weather	•
CENTRALIZED MONITORING	
8" LCD Display	•
Engine Speed or Trip Meter / Accel.	•
Engine Coolant Temperature Gauge	•
Automatic power boost function	•
Low Speed / High Speed	•
Auto Idle	•
Overload warning device	•
Engine Connected Diagnostics	•
Air filters monitoring	•
ECO Gauges	•
Fuel Level Gauge	•
DEF level gauge	•
Hyd. oil temperature gauge	•
Fuel Warmer	•
Clock	•
Cabin lights (Halogen or LED)	•
Cabin Front Window Rain Guard	•
SEAT	
Adjustable air suspension seat with heater	•
Adjustable mechanical suspension seat with heater	•
CABIN FOPS/FOG (ISO/DIS 10262) LEVEL 2	
FOPS (Falling Object Protective Structure) - ISO 3449 Level 2	•
FOG (Falling Object Guard)	•
CABIN ROPS (ISO 12117-2)	
ROPS (Roll Over Protective Structure)	•

SAFETY	STD
Battery Master Switch	•
Rearview Camera	•
AAVM (Advanced Around View Monitoring)	•
4 boomlamps and 2 front working lamps	•
Travel Alarm	•
Rear work lamp (Halogen or LED)	•
Beacon lamp (Halogen or LED)	•
Automatic Swing Brake	•
Boom Holding System	•
Arm Holding System	•
Safety lock valve for boom cylinder with overload warning device	•
Safety Lock Valve for Arm Cylinder	•
Swing Lock System	•
Three outside rearview mirrors	•

OTHER	STD
BOOMS	
6.15 m; 20' 2"	
6.5 m; 21' 4"	•
ARMS	
2.5 m; 8' 2"	
3.2 m; 10' 6"	•
3.9 m; 12' 10"	
Removable Clean-Out Dust Net for Cooler	•
Removable reservoir tank	•
Fuel pre-filter with water separator	•
Fuel Warmer	•
Self-Diagnostics System	•
Hi-Mate (Remote Management System)	•
Batteries (2 x 12 V x 160 Ah)	•
Fuel filler pump with automatic stop function (50 l/min)	•
Single-Acting Piping Kit (Breaker, etc.)	•
Double-Acting Piping Kit (Clamshell, etc.)	•
Rotating Piping Kit	•
Quick Coupler Piping	•
Quick Coupler	•
Engcon tiltrator	•
Boom Floating Control	•
One Pedal Straight Travel System	•
Accumulator for Lowering Work Equipment	•
Pattern Change Valve (2 Patterns)	•
Fine Swing Control System	•
Tool Kit	•

UNDERCARRIAGE	STD
Lower frame reinforced coverplates	•
Lower frame normal coverplates	•
TRACK SHOES	
Triple Grousers Shoes (600 mm, 24")	•
Triple Grousers Shoe (700 mm, 28")	•
Triple Grousers Shoe (800 mm, 32")	•
Triple Grousers Shoe (900 mm, 36")	•
Double Grousers Shoe (600 mm, 24")	•
Track rail guards 2EA	•
Full Track Rail Guard	•

- Standard and optional equipment may vary. Contact your Hyundai dealer for more information. The machine may vary according to International standards.
- The photos may include attachments and optional equipment that are not available in your area.
- Materials and specifications are subject to change without advance notice.
- All imperial measurements rounded off to the nearest pound or inch.



Specifications and design are subject to change without notice. Pictures of Hyundai Construction Equipment Europe products may show other than standard equipment.

Hyundai Construction Equipment Europe nv.
Hyundailaan 4, 3980 Tessenderlo, Belgium.
Tel: (32) 14-56-2200 Fax: (32) 14-59-3405

EN - 2020.06 Rev 0

**Ready to experience the Hyundai Effect?
Contact your Hyundai dealer.
hyundai-ce.eu/en/dealer-locator**

