

CRAWLER EXCAVATOR  
**HX210AL**

HX210ANL



# READY TO CHANGE YOUR WORLD

The HX210AL and HX210ANL Crawler Excavators are part of Hyundai's new A-series: a fresh generation of construction equipment that complies with the European stage V emission levels. But it goes much further than that! While fulfilling regulatory demands, Hyundai aimed for a groundbreaking level of customer satisfaction with maximum performance and productivity, better safety, more convenience and improved uptime management.

With a robust exterior design and smart performance-enhancing technologies, these hard-working machines open up a world of new possibilities where tiny efforts move mountains. It's time to experience the Hyundai Effect!



Productivity & Efficiency

# POWERFUL AND FUEL-EFFICIENT TO BOOST PRODUCTIVITY

The HX210AL and HX210ANL are powered by a robust Stage V-certified Cummins engine with an innovative integrated after-treatment system that reduces both emissions and maintenance requirements. It delivers all the power you need to handle demanding jobs, along with low maintenance and excellent fuel economy.

A range of smart technologies are included for precise management of the engine output and pump flow rate. A new EPFC (Electronic Pump Flow Control) system improves controllability and reduces operating costs. Additional control and monitoring features help you to further improve productivity every single day.



NEW

**Engine**  
The new Cummins B4.5 engine delivers more power and performance with 780 Nm of peak torque setting a new industry benchmark. Like all A-Series machines, these excavators feature our all-in-one exhaust aftertreatment system which cuts emissions and helps to ensure compliance with European Stage V requirements. Removing the need for EGR leads to enhanced reliability and simplified maintenance. It has also enabled us to reduce operating costs through better fuel economy and longer service intervals.

Tier 4 Final (2014)  
EU Stage-V (2019)

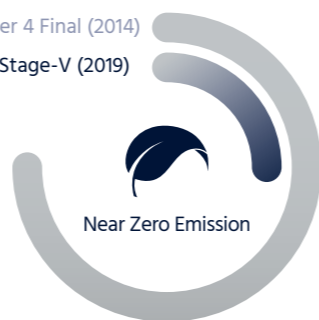

“The smart control technologies are easy to use and save me time and money on every job.”



**Automatic engine shutdown**

The engine shuts down automatically when the machine is at rest to cut fuel consumption and emissions. Different operating modes and idling times can be selected according to the work environment, further enhancing efficiency.

**Eco Gauge**

This feature helps operators to reduce emissions and running costs by displaying the engine workload and fuel-saving status.



NEW

NEW

**Lifting mode**

This work mode improves precision and lift capability through RPM reduction, power boost activation and enhanced pump flow control.

**EPFC (Electronic Pump Flow Control)**

EPFC improves fine control while also reducing fuel consumption. The system allows operators to tailor their machine for the job at hand, ensuring the optimal balance of power and precision.

**Fuel rate information**

Average and latest fuel consumption data are displayed to guide operators towards more economical operation.

**Eco Report**

The Eco Report feature makes it easy for operators to develop efficient working habits by displaying real-time information about machine performance.

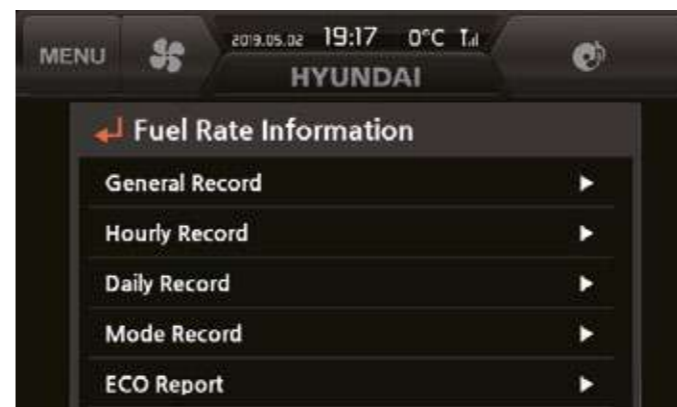

NEW

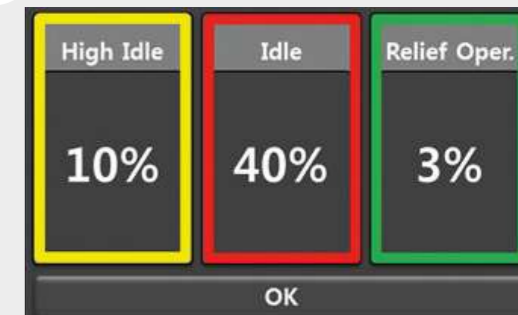

**Durability**

# READY FOR ACTION AND BUILT TO LAST

You need to know that the investment you make today will help to sustain your business over the long term. That's why we prioritised reliability throughout the development of the HX210AL and HX210ANL, from design and manufacturing to quality control. We improved engine reliability by removing the EGR and integrating exhaust after treatment with a simplified, single-module system that's easier to maintain. The upper and lower frame structures are reinforced for high load work, while the attachments have been rigorously tested for the roughest conditions. The overall aim is to minimise downtime and repairs so that you can stay on schedule, avoid unexpected costs and protect your profits.



**"It's tough, dependable and always ready for the next challenge!"**

**Bottom rollers**

The undercarriage is enhanced with nine bottom rollers. As well as improving stability, they reduce track wear and decrease the risk of de-tracking and subsequent damage to tracks.



**Side protectors**

The machine can optionally be equipped with side bumpers to absorb any impact on the exterior frame and protect the machine.

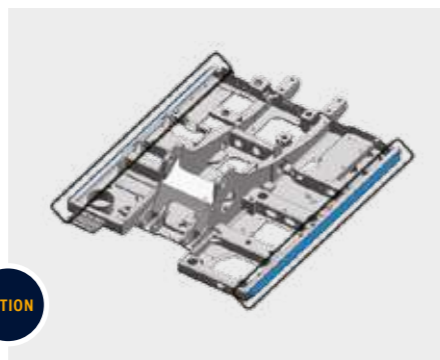

**OPTION**

**Cooling module**

HX A-Series machines are enhanced with a durable cooling module that has been stringently tested to protect productivity in tough working environments.



**Cabin structure**

The cabin structure is reinforced with integrally welded, low-stress, high-strength steel. It is certified to ISO 12117-2 (ROPS - Roll-over Protective Structures) and ISO 10262 Level 2 (FOPS - Falling Object Protective Structures) safety standards.

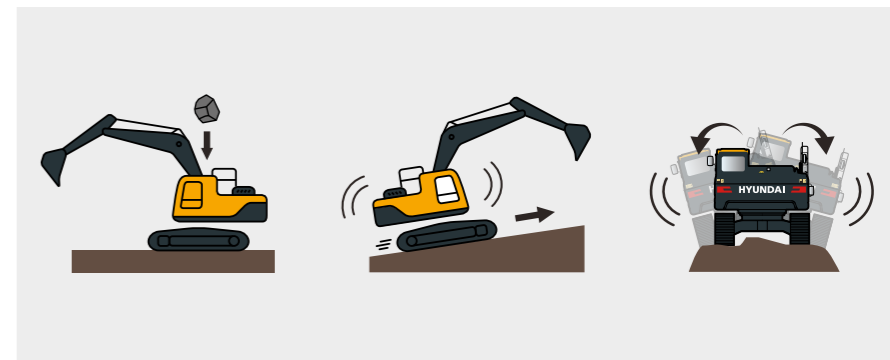

## Operator Comfort

# A CABIN DESIGNED AROUND YOU

The cabin is designed to provide every operator with a comfortable working environment that boosts productivity and reduces fatigue. It includes a high-quality seat and a well thought-out layout that places the most important controls within easy reach. A range of options helps you to tailor the cabin to your needs, including an integrated audio system with radio, USB and AUX input to keep you entertained during your working day. The overall design places you right at the centre of the Hyundai Effect, with a world of convenience at your fingertips.



NEW

### Key On Init Work Mode

This feature allows operators to save the attachment mode setting so that the machine is automatically in the right work mode when re-starting.



### Owner Menu Editing (OME)

Menu functions can be set by the machine owner, who can also provide or restrict access for machine users by using a password to lock or unlock the list.

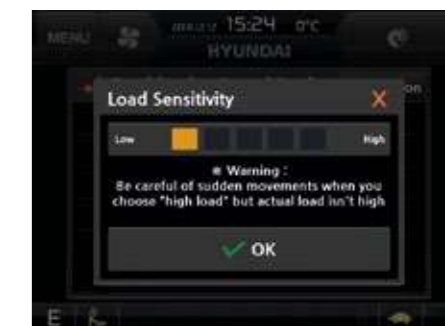

### Combination speed setting system

This system allows operators to balance load sensitivity and boom priority against arm and swing. Select from five levels of load sensitivity to adjust initial flow rate for boom-up and arm-in operation according to attachment weight. Ten levels of boom priority can be selected to balance boom operation against arm and swing.



### Wide touchscreen monitor

The HX210AL and HX210ANL feature an 8-inch display with a touchscreen and excellent legibility. All the indicators displaying machine status are centralised in one cluster to enable easy, efficient control.



NEW

### Improved visibility and access

The open design of the cabin door gives the operator a clear, unimpeded view to the exterior. The door handle has also been redesigned for safer, more convenient access. The right-hand side of the machine also features a new design that gives the operator a better view of the bottom right-hand side of the excavator.



OPTION

### Straight travel pedal

The straight travel pedal option adds to comfort and convenience when travelling long distances or combining travel and attachment operation.

### Proportional auxiliary hydraulic control

The optional proportional control system can be operated using sliders on the gear lever, offering the operator more efficient and convenient control over the speed of work tools, especially in jobs requiring high precision or full-speed operation. Alternatively, control of the system can be switched over to a foot pedal via the settings menu.

OPTION

### Fine swing control

Fine cushion swing control enables smooth movement at the beginning and end of swing operations. Fine free swing control reduces shaking of the weight during lifting.

OPTION



### Jog dial module

For added convenience, the accelerator, remote air conditioner controller and instrument cluster can be operated using the integrated jog dial module.



OPTION

### Miracast connectivity

The Miracast system based on the operator's smartphone Wi-Fi allows the use of various smartphone features on the screen, including navigation, web surfing and music and video playback.

Safety

# PROTECTION FOR YOUR CO-WORKERS AND EQUIPMENT

Small details can make a huge difference when it comes to safety and security. The HX210AL and HX210ANL offer all-round protection for you, your workmates and your machinery. The cabin allows optimal visibility, while optional Advanced Around View Monitoring (AAVM) gives you a clear overview of your surroundings. By helping to ensure an accident-free worksite, these crawler excavators contribute to the peace of mind and productivity that form part of the Hyundai Effect.



“New technologies have been added to protect machine operators and make the construction site a safer place.”



**Seat belt warning alarm**

Operators are reminded to fasten their seat belt by an audible and visible alarm.

**Advanced Around View Monitoring (AAVM)**

The AAVM camera system gives you a 360° overview of your immediate working environment. It also includes Intelligent Moving Object Detection (IMOD) technology that senses and warns you when people or objects come within five metres of the machine.

**Electronic swing parking system**

The swing brake is controlled by an electronic valve and control system to improve safety and efficiency.

**Auto safety lock**

The auto safety lock feature prevents unintentional ignition. When the lock is activated, the excavator is not controlled by the RCV lever.



OPTION

NEW

NEW

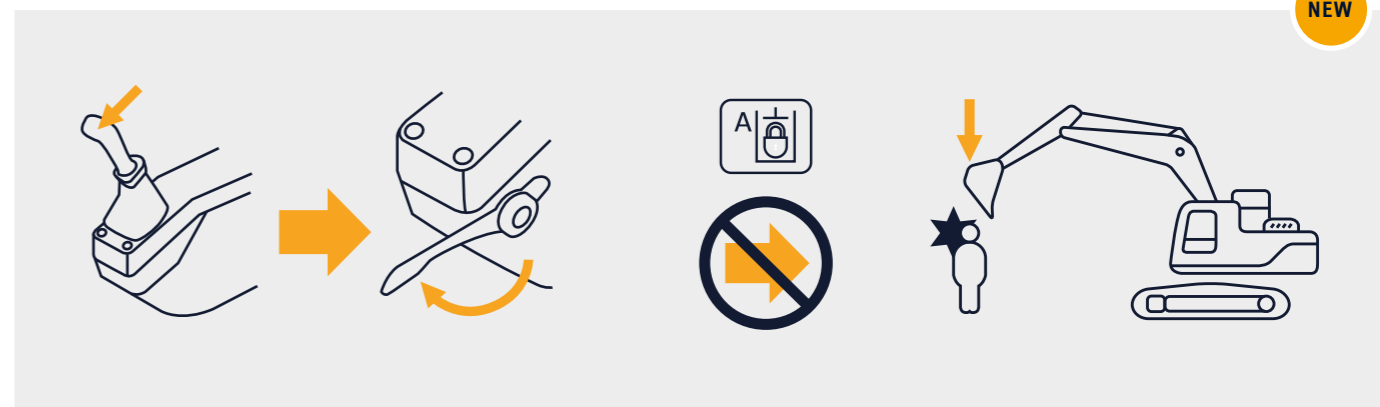

Serviceability & Connectivity

# ADVANCED DIAGNOSTICS AND SERVICING SUPPORT

The peace of mind that comes with quick, low-effort servicing is also part of the Hyundai Effect. The HX210AL and HX210ANL are designed to make maintenance as convenient as possible. All components and materials have been optimised to ensure a long, trouble-free life. Hyundai's innovative Hi MATE telematics system enables full monitoring of machine activity and performance. Maximum connectivity is integrated to help you create a smart construction site and protect your profitability.

"The new technologies make it easy to keep track of servicing tasks and get extra support if I need it."

**HCE Diagnostic Tools (HCE-DT) app**

Technicians can connect wirelessly to the machine on-site using a smartphone or laptop. A quick check can be performed to diagnose the root cause of a failure or to troubleshoot for fault codes. The HCE-DT app retrieves machine and engine data from a combined cloud-based platform to run a failure analysis in real-time. Combined with ECD, it increases first-visit fix rates.



**Upgraded urea tank cover**

The urea tank cover has been updated to a fully open type to make filling more convenient.



**Mobile Fleet app**

Hyundai's new Mobile Fleet app provides all the information you need to run your fleet efficiently and economically. Based on telematics, this advanced solution uses simple graphics and key performance data for smart fleet management.

**200%**  
improved

**Extended fuel filter lifetime**

The fuel filter service interval has been increased from 500 hours to 1,000 hours. DPF cleaning is only required if alerted by a fault indication, eliminating the need for regular ash cleaning intervals.

**HiMATE**

**Boost efficiency and performance**

For maximum convenience and security, the HX210AL and HX210ANL feature Hyundai's exclusive Hi MATE remote fleet management system, which uses mobile data technology to provide the highest level of service and support. You can monitor your equipment wherever you are via a dedicated website or mobile app, with access to working parameters like total engine hours, machine utilisation, actual performed working hours and fuel consumption and machine location.

OPTION



**ECD (Engine Connected Diagnostics)**

ECD provides troubleshooting advice as well as tailored servicing and parts support from Cummins Quick Serve. Service technicians are supported with remote diagnostics reports allowing them to prepare for site visits and bring the right tools.

**We're all connected!**



**Just 5 minutes**



**One-stop solution**



**Increase productivity**

By providing information such as service hours, idle time and fuel consumption, Hi MATE saves you money and improves productivity. Service alerts enable better maintenance planning.



**Monitor your machines**

Hi MATE's real-time location information allows better, more convenient monitoring of your equipment. Just log onto the Hi MATE website or mobile app to see your machines at any time, from any location. Receive data online, by e-mail or directly on your mobile device.



**Improve security**

Protect your equipment from theft or unauthorised usage. Hi MATE's geofencing alerts notify you automatically when a machine leaves a predetermined zone.

Parts & Warranties

# HYUNDAI GENUINE PARTS AND WARRANTIES: THE BEST WAY TO PROTECT YOUR INVESTMENT

Hyundai Genuine parts, accessories and warranty programmes are specially designed to keep your machine covered. They increase uptime and maintain the performance, comfort, and convenience that are built into your equipment.



## A network you can rely on

Hyundai Construction Equipment Europe prioritises quick, reliable intervention to keep your equipment running reliably. In the 13,000 m<sup>2</sup> warehouse, Hyundai covers over 96% of all Genuine Parts. With one of Europe's most advanced automated warehousing systems, we are able to maintain availability and efficient delivery of all our Genuine Parts. Moreover, we guarantee a 24-hour delivery service across our European dealer network.



**Fuel filters**

Hyundai fuel filters provide the right degree of filtration to keep your engine clean. They are designed to meet and exceed the engine manufacturer's prerequisites for water separation and dirt filtration, prolonging the life of your engine.



**Hyundai Genuine parts**

Hyundai Genuine parts have the same design as those installed when your machine left the factory. They are subjected to rigorous quality inspections and tests to make sure they meet Hyundai's strict requirements for quality and durability. As well as minimising downtime, this helps to ensure peak performance on every task.



**Aftermarket kits**

You can order Hyundai aftermarket kits via your dealer. This AAVM system for example, improves safety in and around your working environment at all times.



## Hyundai warranties

Our warranties are also designed to give you the cover you need to build your business with confidence and peace of mind.

**Standard warranties**

We offer standard warranty coverage for all crawler excavators. Next to this standard coverage, optional and extended warranty periods are available, so you can benefit from full warranty coverage for longer, and even over the full lifetime of the machines. Please discuss the optimal solution for your needs with your local Hyundai dealer.

**Extended warranties**

Our extended warranties help you maintain full control over your operating costs. If you combine an extended warranty programme with a tailored maintenance contract, you can completely avoid unexpected costs.



## Walk-around

# HX210AL / HX210ANL

### Productivity & Efficiency

- High-torque 4-cylinder EGR-free engine (best-in-class) **NEW**
- Eco Report **NEW**
- Electronic Pump Flow Control (EPFC) **NEW**
- Lifting mode **NEW**
- Fuel Rate Information
- Eco Gauge
- Automatic engine shutdown

### Serviceability

- Engine Connected Diagnostics (ECD) **NEW**
- Hi MATE telematics system **OPTION**
- 2x longer-lasting fuel filter (1,000 hrs)
- Upgraded urea tank cover
- Mobile Fleet app
- Connected diagnostics



### Durability

- Side protector **OPTION**
- FOPS/ROPS cabin
- Reinforced upper and lower structure
- Reinforced attachments
- Durable cooling module

### Operator Comfort

- Key On Init Work Mode **NEW**
- Straight travel pedal **OPTION**
- Proportional auxiliary hydraulic system **OPTION**
- 2-way proportional RCV & pedal control selection **OPTION**
- Fine (cushion/free) swing Control **OPTION**
- 8" touchscreen monitor
- Jog dial module
- Owner Menu Editing (OME)
- Combination speed system

### Safety

- Auto safety lock **NEW**
- Electronic swing parking brake **NEW**
- AAVM camera system **OPTION**
- Seat belt warning alarm

# READY TO CHANGE YOUR WORLD

Hyundai's crawler excavators are designed to create better conditions for operators and deliver the ultimate ownership experience. Every detail is carefully fine-tuned to match your needs in the field, including better safety and comfort, higher productivity, maximum uptime and easy servicing. It's all part of the Hyundai Effect.

**Explore the range at [hyundai-ce.eu](https://hyundai-ce.eu)**



# SPECIFICATIONS

ENGINE	
Maker / Model	CUMMINS / B4.5
Type	4 cylinder, watercooled, 4-cycle, turbocharged charge aircooled, direct injection, electronic controlled diesel engine
Gross Power	129 kW (173 hp) at 2,200 rpm
Net Power	127 kW (170 hp) at 2,200 rpm
Max. Power	142 kW (190 hp) at 2,000 rpm
Peak Torque	780 N. m (575 lb. ft) at 1,500 rpm
Displacement	4.5 l (275 cu in)

HYDRAULIC SYSTEM	
<b>MAIN PUMP</b>	
Type	Variable Displacement Tandem Axis Piston Pumps
Max. Flow	2 x 234 l/min
Sub-Pump For Pilot Circuit	Gear Pump
Cross-sensing and fuel saving pump system.	

HYDRAULIC MOTORS	
Travel	Two speed axial pistons motor with brake valve and parking brake
Swing	Axial piston motor with automatic brake
<b>RELIEF VALVE SETTING</b>	
Implement Circuits	350 kgf/cm <sup>2</sup> (4,980 psi)
Travel	350 kgf/cm <sup>2</sup> (4,980 psi)
Power Boost (Boom, Arm, Bucket)	380 kgf/cm <sup>2</sup> (5,400 psi)
Swing Circuit	290 kgf/cm <sup>2</sup> (4,125 psi)
Pilot Circuit	40 kgf/cm <sup>2</sup> (570 psi)
Service Valve	Installed

HYDRAULIC CYLINDERS	
No. of cylinder bore x stroke	Boom: Ø120×1,290 mm Arm: Ø140×1,510 mm Bucket: Ø120×1,055 mm

\* Hyundai Bio Hydraulic Oil (HBHO) available.

DRIVES & BRAKES	
Drive Method	Fully Hydrostatic Type
Drive Motor	Axial Piston Motor, In-Shoe Design
Reduction System	Planetary Reduction Gear
Max. Drawbar Pull	20,800 kgf (45,860 lbf)
Max. Travel Speed (High / Low)	5.8 km/hr (3.6 mph) / 3.7 km/hr (2.3 mph)
Gradeability	35° (70%)
Parking Brake	Multi Wet Disc

CONTROL	
Pilot pressure operated joysticks and pedals with detachable lever provide almost effortless and fatigueless operation.	
Pilot Control	Two Joysticks with One Safety Lever (LH): Swing and Arm, Boom and Bucket
Travelling and Steering	Two Levers With Pedals
Engine Throttle	Electric, Dial Type

SWING SYSTEM	
Swing Motor	Fixed Displacement Axial Piston Motor
Swing Reduction	Planetary Gear Reduction
Swing Bearing Lubrication	Grease-Bathed
Swing Brake	Multi Wet Disc
Swing Speed	12 rpm

CAPACITIES			
	litre	US gal	UK gal
Fuel Tank	400	106	88
Engine Coolant	40	10.6	8.8
Engine Oil	23.1	6.1	5.1
Swing Device	6.2	1.64	1.36
Final Drive (Each)	4.5	1.2	1
Hydraulic System (Including Tank)	275	72.6	60.5
Hydraulic Tank	155	40.9	34.1
DEF/AdBlue®	48	12.6	10.5

UNDERCARRIAGE	
Centre Frame	X - Leg Type
Track Frame	Pentagonal Box Type
No. of Shoes on Each Side	49 EA
No. of Carrier Roller on Each Side	2 EA
No. of Track Roller on Each Side	9 EA
No. of Rail Guard on Each Side	2 EA

OPERATING WEIGHT (APPROXIMATE)			
Operating weight, including 5,650 mm (18' 6") boom, 2,920 mm (9' 7") arm, SAE heaped 0.92 m <sup>3</sup> (1.20 yd <sup>3</sup> ) bucket, lubricant, coolant, full fuel tank, full hydraulic tank, and all standard equipments.			

OPERATING WEIGHT				
Shoes	Width mm (in)	Operating Weight kg (lb)	Ground Pressure kgf/cm <sup>2</sup> (psi)	
Triple Grouser	500 (20")	HX210ANL 22,800 (50,270)	0.58 (8.29)	
	600 (24")	HX210AL 22,150 (48,830)	0.47 (6.71)	
		HX210ANL 22,900 (50,490)	0.49 (6.93)	
	700 (28")	HX210AL 22,620 (49,870)	0.41 (5.87)	
	800 (32")	HX210AL 22,890 (50,460)	0.37 (5.20)	
Double Grouser	900 (36")	HX210AL 23,170 (51,080)	0.33 (4.68)	
	700 (28")	HX210AL 22,880 (50,440)	0.42 (5.94)	

AIR CONDITIONING SYSTEM	
The air conditioning system contains fluorinated greenhouse gas refrigerant R134a (Global Warming Potential = 1,430). The system contains 0.75 kg of refrigerant representing a CO <sub>2</sub> equivalent of 1.0725 metric tonnes.	

# DIMENSIONS & WORKING RANGE

## HX210AL / HX210ANL MONO BOOM DIMENSIONS

5,65 m (18' 6") BOOM and 2.0 m (6' 7"), 2.4 m (7' 10"), 2.92 m (9' 7"), 3.9 m (12' 10") ARM

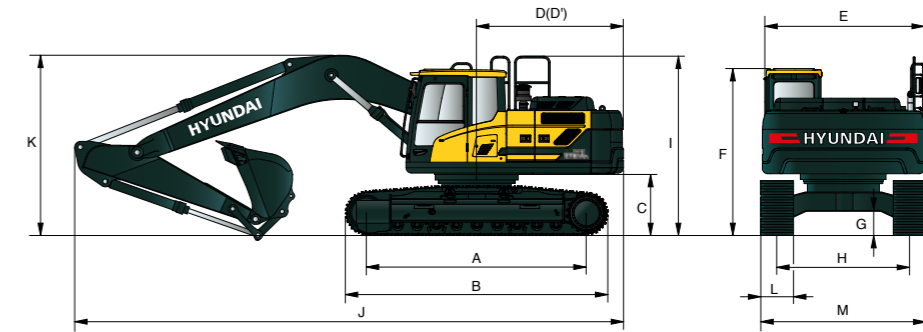

Unit : mm (ft. in.)

A Tumbler Distance	3,650 (12' 0")
B Overall Length of Crawler	4,404(14' 4")
C Ground Clearance of Counter weight	1,060 (3' 6")
D Tail Swing Radius	2,850 (9' 4")
D' Rear-End Length	2,770 (9' 1")
E Overall Width of Upperstructure	2,530 (8' 3")
F Overall Height of Cab	3,000 (9' 8")
G Min. Ground Clearance	470 (1' 7")
H Track Gauge	HX210AL 2,390 (7' 10")
	HX210ANL 2,000 (6' 7")
I Overall Height of Guardrail	3,210 (10' 5")

Boom Length	5,650 (18' 6")			
Arm Length	2,000 (6' 7")	2,400 (7' 10")	2,920 (9' 7")	3,900 (12' 10")
J Overall Length	9,650 (31' 8")	9,570 (31' 5")	9,510 (31' 2")	9,480 (31' 1")
K Overall Height of Boom	3,250 (10' 8")	3,170 (10' 5")	3,100 (10' 2")	3,500 (11' 6")

### HX210AL

L Track Shoe Width	TRIPLE GROUSER				DOUBLE GROUSER
	600 (24")	700 (28")	800 (32")	900 (35")	700 (28")
M Overall Width	2,990 (9' 10")	3,090 (10' 2")	3,190 (10' 6")	3,290 (10' 10")	3,090 (10' 2")

### HX210ANL

L Track Shoe Width	TRIPLE GROUSER	
	500 (20")	600 (24")
M Overall Width	2,555 (8' 5")	2,655 (8' 9")

\* This figure includes the size of grousers.

## HX210AL / HX210ANL MONO BOOM WORKING RANGE

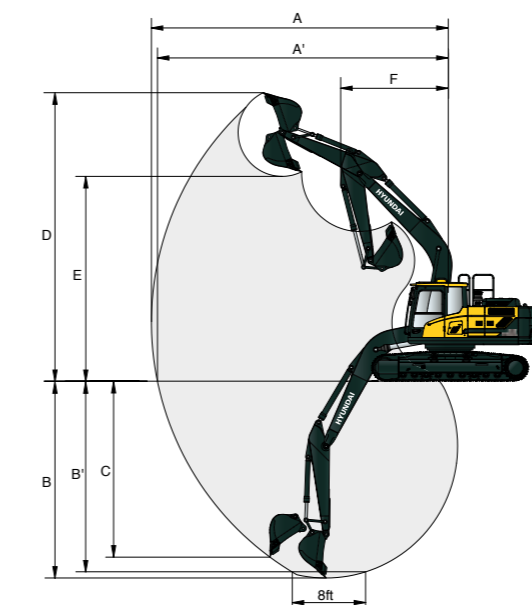

Unit : mm (ft. in.)

Boom Length	5,650 (18' 6")			
Arm Length	2,000 (6' 7")	2,400 (7' 10")	2,920 (9' 7")	3,900 (12' 10")
A Max. Digging Reach	9,140 (30' 0")	9,500 (31' 2")	9,960 (32' 8")	10,900 (35' 9")
A' Max. Digging Reach on Ground	8,960 (29' 5")	9,340 (30' 8")	9,800 (32' 2")	10,750 (35' 3")
B Max. Digging Depth	5,750 (18' 10")	6,150 (20' 2")	6,640 (21' 9")	7,610 (25' 0")
B' Max. Digging Depth (8' Level)	5,520 (18' 1")	5,950 (19' 6")	6,470 (21' 3")	7,460 (24' 6")
C Max. Vertical Wall Digging Depth	5,320 (17' 5")	5,780 (19' 0")	6,250 (20' 6")	6,940 (22' 9")
D Max. Digging Height	9,270 (30' 5")	9,500 (31' 2")	9,740 (31' 11")	10,310 (33' 10")
E Max. Dumping Height	6,450 (21' 2")	6,660 (21' 10")	6,900 (22' 8")	7,470 (24' 6")
F Min. Swing Radius	3,710 (12' 2")	3,630 (11' 11")	3,580 (11' 9")	6,850 (22' 6")

# DIMENSIONS & WORKING RANGE

## HX210AL / HX210ANL 2-PIECE BOOM DIMENSIONS

5.65 m (18' 6") 2-Piece BOOM and 2.0 m (6' 7"), 2.4 m (7' 10"), 2.92 m (9' 7") ARM

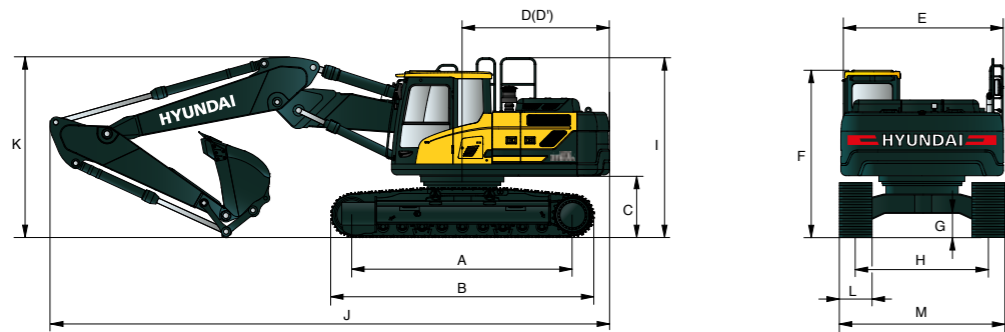

Unit : mm (ft. in.)

A	Tumbler Distance	3,650 (12' 0")
B	Overall Length of Crawler	4,404(14' 4")
*C	Ground Clearance of Counter weight	1,060 (3' 6")
D	Tail Swing Radius	2,850 (9' 4")
D'	Rear-End Length	2,770 (9' 1")
E	Overall Width of Upperstructure	2,530 (8' 3")
*F	Overall Height of Cab	3,000 (9' 8")
*G	Min. Ground Clearance	470 (1' 7")
H	Track Gauge	HX210AL 2,390 (7' 10")
		HX210ANL 2,000 (6' 7")
I	Overall Height of Guardrail	3,210 (10' 5")

<b>Boom Length</b>		5,650 2-Piece (18' 6")		
<b>Arm Length</b>		2,000 (6' 7")	2,400 (7' 10")	2,920 (9' 7")
J	<b>Overall Length</b>	9,650 (31' 8")	9,550 (31' 4")	9,520 (31' 3")
*K	<b>Overall Height of Boom</b>	3,200 (10' 6")	3,000 (9' 10")	3,030 (9' 11")

### HX210AL

L	Track Shoe Width	TRIPLE GROUSER				DOUBLE GROUSER
		600 (24")	700 (28")	800 (32")	900 (35")	700 (28")
M	<b>Overall Width</b>	2,990 (9' 10")	3,090 (10' 2")	3,190 (10' 6")	3,290 (10' 10")	3,090 (10' 2")

### HX210ANL

L	Track Shoe Width	TRIPLE GROUSER	
		500 (20")	600 (24")
M	<b>Overall Width</b>	2,555 (8' 5")	2,655 (8' 9")

\* This figure includes the size of grousers.

## HX210AL / HX210ANL 2-PIECE BOOM WORKING RANGE

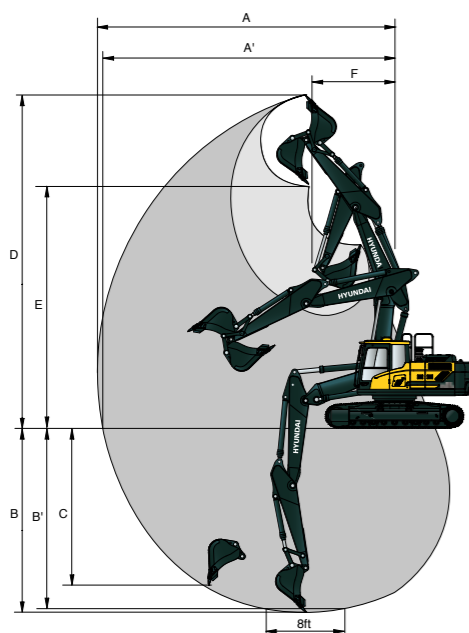

Unit : mm (ft. in.)

<b>Boom Length</b>		5,650 2-Piece (18' 6")		
<b>Arm Length</b>		2,000 (6' 7")	2,400 (7' 10")	2,920 (9' 7")
A	<b>Max. Digging Reach</b>	9,120 (29' 11")	9,530 (31' 3")	10,020 (32' 10")
A'	<b>Max. Digging Reach on Ground</b>	8,940 (29' 4")	9,360 (30' 9")	9,860 (32' 4")
B	<b>Max. Digging Depth</b>	5,480 (18' 0")	5,890 (19' 4")	6,400 (21' 0")
B'	<b>Max. Digging Depth (8' Level)</b>	5,360 (17' 7")	5,770 (18' 11")	6,300 (20' 8")
C	<b>Max. Vertical Wall Digging Depth</b>	4,560 (15' 0")	4,990 (16' 4")	5,530 (18' 2")
D	<b>Max. Digging Height</b>	10,300 (33' 10")	10,670 (35' 0")	11,080 (36' 4")
E	<b>Max. Dumping Height</b>	7,390 (24' 3")	7,740 (25' 5")	8,160 (26' 9")
F	<b>Min. Swing Radius</b>	2,870 (9' 5")	2,670 (8' 9")	2,540 (8' 4")

# LIFTING CAPACITY

Rating over-front Rating over-side or 360 degrees

## HX210AL MONO BOOM

Boom 5.65 m (18' 6") / Arm 2.0 m (6' 7") / CWT 3,800 kg (8,380 lb) / Shoe 800 mm (32") triple grouser

Lift-point height m (ft)	Lift-point radius								At max. Reach		
	3.0 m (9.8 ft)		4.5 m (14.8 ft)		6.0 m (19.7 ft)		7.5 m (24.6 ft)		Capacity	Reach	
											m (ft)
7.5 m (24.6 ft)	kg								*5,720	*5,720	4.96
	lb								*12,610	*12,610	(16.3)
6.0 m (19.7 ft)	kg			*5,470	5,230				*5,550	4,790	6.32
	lb			*12,060	11,530				*12,240	10,560	(20.7)
4.5 m (14.8 ft)	kg		*6,860	*6,860	*5,810	5,110			*5,600	3,920	7.11
	lb		*15,120	*15,120	*12,810	11,270			*12,350	8,640	(23.3)
3.0 m (9.8 ft)	kg		*8,680	7,370	*6,550	4,900	5,470	3,530	5,450	3,520	7.52
	lb		*19,140	16,250	*14,440	10,800	12,060	7,780	12,020	7,760	(24.7)
1.5 m (4.9 ft)	kg				*7,290	4,710	5,390	3,460	5,280	3,390	7.61
	lb				*16,070	10,380	11,880	7,630	11,640	7,470	(25.0)
Ground Line	kg		*10,590	6,850	7,370	4,590			6,100	3,480	7.40
	lb		*23,350	15,100	16,250	10,120			13,450	7,670	(24.3)
-1.5 m (-4.9 ft)	kg		*10,320	6,870	7,360	4,580			6,100	3,870	6.85
	lb		*22,750	15,150	16,230	10,100			13,450	8,530	(22.5)
-3.0 m (-9.8 ft)	kg	*12,600	*12,600	*9,240	7,000				*6,790	4,860	5.87
	lb	*27,780	*27,780	*20,370	15,430				*14,970	10,710	(19.3)
-4.5 m (-14.8 ft)	kg										
	lb										



Boom 5.65 m (18' 6") / Arm 2.4 m (7' 10") / CWT 3,800 kg (8,380 lb) / Shoe 800 mm (32") triple grouser

Lift-point height m (ft)	Lift-point radius								At max. Reach		
	3.0 m (9.8 ft)		4.5 m (14.8 ft)		6.0 m (19.7 ft)		7.5 m (24.6 ft)		Capacity	Reach	
											m (ft)
7.5 m (24.6 ft)	kg								*4,900	*4,900	5.55
	lb								*10,800	*10,800	(18.2)
6.0 m (19.7 ft)	kg			*5,010	*5,010				*4,430	4,290	6.79
	lb			*11,050	*11,050				*9,770	9,460	(22.3)
4.5 m (14.8 ft)	kg		*6,310	*6,310	*5,450	5,140	*4,610	3,600	*4,300	3,580	7.53
	lb		*13,910	*13,910	*12,020	11,330	*10,160	7,940	*9,480	7,890	(24.7)
3.0 m (9.8 ft)	kg		*8,130	7,460	*6,240	4,920	*5,450	3,530	*4,380	3,240	7.92
	lb		*17,920	16,450	*13,760	10,850	*12,020	7,780	*9,660	7,140	(26.0)
1.5 m (4.9 ft)	kg		*9,720	7,020	*7,050	4,700	5,370	3,440	*4,650	3,130	8.01
	lb		*21,430	15,480	*15,540	10,360	11,840	7,580	*10,250	6,900	(26.3)
Ground Line	kg		*10,470	6,820	7,340	4,570	5,310	3,370	5,020	3,200	7.8
	lb		*23,080	15,040	16,180	10,080	11,710	7,430	11,070	7,050	(25.6)
-1.5 m (-4.9 ft)	kg	*11,180	*11,180	*10,420	6,800	7,300	4,530		5,530	3,510	7.29
	lb	*24,650	*24,650	*22,970	14,990	16,090	9,990		12,190	7,740	(23.9)
-3.0 m (-9.8 ft)	kg	*13,470	*13,470	*9,600	6,900	*7,030	4,610		*6,400	4,270	6.38
	lb	*29,700	*29,700	*21,160	15,210	*15,500	10,160		*14,110	9,410	(20.9)
-4.5 m (-14.8 ft)	kg			*7,230	7,200				*6,450	*6,450	4.85
	lb			*15,940	15,870				*14,220	*14,220	(15.9)

- Lifting capacity is based on ISO 10567.
- Lifting capacity of HX A Series does not exceed 75% of tipping load with the machine on firm, level ground or 87% of full hydraulic capacity.
- The Lift-point is bucket pivot mounting pin on the arm (without bucket mass).
- (\*) indicates load limited by hydraulic capacity.
- Caution: please be aware of the local regulations and instructions for lifting operations.













# LIFTING CAPACITY















 Rating over-front  Rating over-side or 360 degrees

## HX210AL 2-PIECE BOOM

Boom 5.65 m (18' 6") / Arm 2.92 m (9' 7") / CWT 3,800 kg (8,380 lb) / Shoe 800 mm (32") triple grouser

Lift-point height m (ft)	Lift-point radius								At max. Reach			
	3.0 m (9.8 ft)		4.5 m (14.8 ft)		6.0 m (19.7 ft)		7.5 m (24.6 ft)		Capacity		Reach	
											m (ft)	
9.0m (29.5ft)	kg									*3,940	*3,940	4.46
	lb									*8,690	*8,690	(14.6)
7.5 m (24.6 ft)	kg			*6,020	*6,020	*4,590	*4,590			*3,130	*3,130	6.32
	lb			*13,270	*13,270	*10,120	*10,120			*6,900	*6,900	(20.7)
6.0 m (19.7 ft)	kg			*6,170	*6,170	*4,950	*4,950			*2,830	*2,830	7.43
	lb			*13,600	*13,600	*10,910	*10,910			*6,240	*6,240	(24.4)
4.5 m (14.8 ft)	kg	*9,140	*9,140	*6,930	*6,930	*5,220	5,180	*4,200	3,590	*2,730	*2,730	8.11
	lb	*20,150	*20,150	*15,280	*15,280	*11,510	11,420	*9,260	7,910	*6,020	*6,020	(26.6)
3.0 m (9.8 ft)	kg			*8,690	7,550	*5,770	4,900	*4,380	3,470	*2,750	*2,750	8.47
	lb			*19,160	16,640	*12,720	10,800	*9,660	7,650	*6,060	*6,060	(27.8)
1.5 m (4.9 ft)	kg			*10,100	6,960	*6,520	4,620	*4,640	3,340	*2,870	2,730	8.55
	lb			*22,270	15,340	*14,370	10,190	*10,230	7,360	*6,330	6,020	(28.1)
Ground Line	kg			*10,160	6,640	*7,260	4,430	*4,890	3,240	*3,130	2,790	8.36
	lb			*22,400	14,640	*16,010	9,770	*10,780	7,140	*6,900	6,150	(27.4)
-1.5 m (-4.9 ft)	kg	*10,190	*10,190	*9,300	6,550	*6,970	4,350	*5,040	3,220	*3,600	3,020	7.88
	lb	*22,470	*22,470	*20,500	14,440	*15,370	9,590	*11,110	7,100	*7,940	6,660	(25.9)
-3.0 m (-9.8 ft)	kg	*9,470	*9,470	*7,530	6,630	*5,620	4,390			*3,990	3,580	7.05
	lb	*20,880	*20,880	*16,600	14,620	*12,390	9,680			*8,800	7,890	(23.1)

Boom 5.65 m (18' 6") / Arm 3.9 m (12' 10") / CWT 3,800 kg (8,380 lb) / Shoe 800 mm (32") triple grouser

Lift-point height m (ft)	Lift-point radius										At max. Reach						
	1.5 m (4.9 ft)		3.0 m (9.8 ft)		4.5 m (14.8 ft)		6.0 m (19.7 ft)		7.5 m (24.6 ft)		9.0 m (29.5 ft)		Capacity		Reach		
															m (ft)		
9.0m (29.5ft)	kg														*2,530	*2,530	6.1
	lb														*5,580	*5,580	(20.0)
7.5 m (24.6 ft)	kg							*4,370	*4,370	*2,390	*2,390			*2,150	*2,150	7.56	
	lb							*9,630	*9,630	*5,270	*5,270			*4,740	*4,740	(24.8)	
6.0 m (19.7 ft)	kg							*4,400	*4,400	*3,670	*3,670			*1,980	*1,980	8.50	
	lb							*9,700	*9,700	*8,090	*8,090			*4,370	*4,370	(27.9)	
4.5 m (14.8 ft)	kg					*4,900	*4,900	*4,630	*4,630	*3,760	3,660	*2,410	*2,410	*1,910	*1,910	9.10	
	lb					*10,800	*10,800	*10,210	*10,210	*8,290	8,070	*5,310	*5,310	*4,210	*4,210	(29.9)	
3.0 m (9.8 ft)	kg			*11,780	*11,780	*7,130	*7,130	*5,100	5,010	*3,950	3,500	*3,230	2,550	*1,910	*1,910	9.43	
	lb			*25,970	*25,970	*15,720	*15,720	*11,240	11,050	*8,710	7,720	*7,120	5,620	*4,210	*4,210	(30.9)	
1.5 m (4.9 ft)	kg					*9,340	7,140	*5,800	4,660	*4,230	3,320	*3,330	2,470	*1,990	*1,990	9.50	
	lb					*20,590	15,740	*12,790	10,270	*9,330	7,320	*7,340	5,450	*4,390	*4,390	(31.2)	
Ground Line	kg			*6,980	*6,980	*10,000	6,620	*6,590	4,380	*4,520	3,170	*3,450	2,400	*2,140	*2,140	9.33	
	lb			*15,390	*15,390	*22,050	14,590	*14,530	9,660	*9,960	6,990	*7,610	5,290	*4,720	*4,720	(30.6)	
-1.5 m (-4.9 ft)	kg	*5,210	*5,210	*9,170	*9,170	*9,770	6,380	7,060	4,210	*4,770	3,070			*2,400	*2,400	8.90	
	lb	*11,490	*11,490	*20,220	*20,220	*21,450	14,070	15,560	9,280	*10,520	6,770			*5,290	*5,290	(29.2)	
-3.0 m (-9.8 ft)	kg			*12,030	*12,030	*8,650	6,350	*6,430	4,180	*4,700	3,070			*2,870	2,760	8.18	
	lb			*26,520	*26,520	*19,070	14,000	*14,180	9,220	*10,360	6,770			*6,330	6,080	(26.8)	
-4.5 m (-14.8 ft)	kg					*6,470	*6,470	*4,670	4,280								
	lb					*14,260	*14,260	*10,300	9,440								













- Lifting capacity is based on ISO 10567.
- Lifting capacity of HX A Series does not exceed 75% of tipping load with the machine on firm, level ground or 87% of full hydraulic capacity.
- The Lift-point is bucket pivot mounting pin on the arm (without bucket mass).
- (\*) indicates load limited by hydraulic capacity.
- Caution: please be aware of the local regulations and instructions for lifting operations.

# LIFTING CAPACITY











 Rating over-front  Rating over-side or 360 degrees

## HX210ANL MONO BOOM

Boom 5.65 m (18' 6") / Arm 2.92 m (9' 7") / CWT 4,700 kg (10,360 lb) / Shoe 500 mm (20") triple grouser

Lift-point height m (ft)	Lift-point radius										At max. Reach													
	1.5 m (4.9 ft)		3.0 m (9.8 ft)		4.5 m (14.8 ft)		6.0 m (19.7 ft)		7.5 m (24.6 ft)		Capacity		Reach											
													m (ft)											
7.5 m (24.6 ft)	kg													*4,250	*4,250	6.24								
	lb													*9,370	*9,370	(20.5)								
6.0 m (19.7 ft)	kg													*4,440	*4,440	7.36								
	lb													*9,790	*9,790	(24.1)								
4.5 m (14.8 ft)	kg													*4,950	4,660	*4,730	3,270	*2,840	*2,840	8.05				
	lb													*10,910	10,270	*10,430	7,210	*6,260	*6,260	(26.4)				
3.0 m (9.8 ft)	kg													*7,370	6,680	*5,790	4,420	*5,090	3,170	*2,880	2,640	8.41		
	lb													*16,250	14,730	*12,760	9,740	*11,220	6,990	*6,350	5,820	(27.6)		
1.5 m (4.9 ft)	kg													*9,140	6,200	*6,690	4,190	*5,540	3,060	*3,040	2,540	8.49		
	lb													*20,150	13,670	*14,750	9,240	*12,210	6,750	*6,700	5,600	(27.9)		
Ground Line	kg													*6,220	*6,220	*10,180	5,940	*7,360	4,030	5,530	2,970	*3,360	2,590	8.30
	lb													*13,710	*13,710	*22,440	13,100	*16,230	8,880	12,190	6,550	*7,410	5,710	(27.2)
-1.5 m (-4.9 ft)	kg	*6,700	*6,700	*10,680	*10,680	*10,430	5,860	7,600	3,950	5,500	2,950			*3,920	2,800	7.82								
	lb	*14,770	*14,770	*23,550	*23,550	*22,990	12,920	16,760	8,710	12,130	6,500			*8,640	6,170	(25.7)								
-3.0 m (-9.8 ft)	kg	*11,310	*11,310	*14,370	11,030	*9,920	5,910	*7,310	3,990					*5,050	3,300	6.98								
	lb	*24,930	*24,930	*31,680	24,320	*21,870	13,030	*16,120	8,800					*11,130	7,280	(22.9)								
-4.5 m (-14.8 ft)	kg													*6,180	4,550	5.63								
	lb													*13,620	10,030	(18.5)								

Boom 5.65 m (18' 6") / Arm 2.40 m (7' 9") / CWT 4,700 kg (10,360 lb) / Shoe 500 mm (20") triple grouser

Lift-point height m (ft)	Lift-point radius								At max. Reach											
	3.0 m (9.8 ft)		4.5 m (14.8 ft)		6.0 m (19.7 ft)		7.5 m (24.6 ft)		Capacity		Reach									
											m (ft)									
7.5 m (24.6 ft)	kg											*4,900	*4,900	5.55						
	lb											*10,800	*10,800	(18.2)						
6.0 m (19.7 ft)	kg											*5,010	4,750	6.79						
	lb											*11,050	10,470	(22.3)						
4.5 m (14.8 ft)	kg											*6,310	*6,310	*5,450	4,620	*4,610	3,250	*4,300	3,230	7.53
	lb											*13,910	*13,910	*12,020	10,190	*10,160	7,170	*9,480	7,120	(24.7)
3.0 m (9.8 ft)	kg											*8,130	6,570	*6,240	4,400	*5,450	3,180	*4,380	2,920	7.92
	lb																			

# LIFTING CAPACITY

Rating over-front Rating over-side or 360 degrees

## HX210ANL 2-PIECE BOOM

Boom 5.65 m (18' 6") / Arm 2.92 m (9' 7") / CWT 3,800 kg (8,380 lb) / Shoe 800 mm (32") triple grouser

Lift-point height m (ft)	Lift-point radius								At max. Reach			
	3.0 m (9.8 ft)		4.5 m (14.8 ft)		6.0 m (19.7 ft)		7.5 m (24.6 ft)		Capacity		Reach	
											m (ft)	
9.0 m (29.5 ft)	kg									*3,940	*3,940	4.46
	lb									*8,690	*8,690	(14.6)
7.5 m (24.6 ft)	kg			*6,020	*6,020	*4,590	*4,590			*3,130	*3,130	6.32
	lb			*13,270	*13,270	*10,120	*10,120			*6,900	*6,900	(20.7)
6.0 m (19.7 ft)	kg			*6,170	*6,170	*4,950	4,800			*2,830	*2,830	7.43
	lb			*13,600	*13,600	*10,910	10,910			*6,240	*6,240	(24.4)
4.5 m (14.8 ft)	kg	*9,140	*9,140	*6,930	*6,930	*5,220	5,190	*4,200	3,600	*2,730	*2,730	8.11
	lb	*20,150	*20,150	*15,280	*15,280	*11,510	11,440	*9,260	7,940	*6,020	*6,020	(26.6)
3.0 m (9.8 ft)	kg			*8,690	7,570	*5,770	4,920	*4,380	3,490	*2,750	2,750	8.47
	lb			*19,160	16,690	*12,720	10,850	*9,660	7,690	*6,060	6,060	(27.8)
1.5 m (4.9 ft)	kg			*10,100	6,980	*6,520	4,640	*4,640	3,350	*2,870	2,740	8.55
	lb			*22,270	15,390	*14,370	10,230	*10,230	7,390	*6,330	6,040	(28.1)
Ground Line	kg			*10,160	6,660	*7,260	4,440	*4,890	3,250	*3,130	2,800	8.36
	lb			*22,400	14,680	*16,010	9,790	*10,780	7,170	*6,900	6,170	(27.4)
-1.5 m (-4.9 ft)	kg	*10,190	*10,190	*9,300	6,570	*6,970	4,360	*5,040	3,230	*3,600	3,030	7.88
	lb	*22,470	*22,470	*20,500	14,480	*15,370	9,610	*11,110	7,120	*7,940	6,680	(25.9)
-3.0 m (-9.8 ft)	kg	*9,470	*9,470	*7,530	6,650	*5,620	4,410			*3,990	3,590	7.05
	lb	*20,880	*20,880	*16,600	14,660	*12,390	9,720			*8,800	7,910	(23.1)

Boom 5.65 m (18' 6") / Arm 2.40 m (7' 9") / CWT 3,800 kg (8,380 lb) / Shoe 800 mm (32") triple grouser

Lift-point height m (ft)	Lift-point radius								At max. Reach			
	3.0 m (9.8 ft)		4.5 m (14.8 ft)		6.0 m (19.7 ft)		7.5 m (24.6 ft)		Capacity		Reach	
											m (ft)	
9.0 m (29.5 ft)	kg									*6,600	*6,600	3.38
	lb									*14,550	*14,550	(11.1)
7.5 m (24.6 ft)	kg			*6,520	*6,520					*4,880	*4,880	5.62
	lb			*14,370	*14,370					*10,760	*10,760	(18.4)
6.0 m (19.7 ft)	kg			*6,640	*6,640	*5,300	5,290			*4,360	4,200	6.85
	lb			*14,640	*14,640	*11,680	11,660			*9,610	9,260	(22.5)
4.5 m (14.8 ft)	kg			*7,560	7,560	*5,560	5,130	*4,500	3,560	*4,200	3,490	7.58
	lb			*16,670	16,670	*12,260	11,310	*9,920	7,850	*9,260	7,690	(24.9)
3.0 m (9.8 ft)	kg			*9,640	7,420	*6,130	4,880	*4,620	3,480	*4,230	3,150	7.97
	lb			*21,250	16,360	*13,510	10,760	*10,190	7,670	*9,330	6,940	(26.1)
1.5 m (4.9 ft)	kg			*10,330	6,910	*6,880	4,630	*4,850	3,370	*4,420	3,040	8.05
	lb			*22,770	15,230	*15,170	10,210	*10,690	7,430	*9,740	6,700	(26.4)
Ground Line	kg			*10,010	6,690	*7,460	4,480	*5,060	3,300	*4,710	3,110	7.85
	lb			*22,070	14,750	*16,450	9,880	*11,160	7,280	*10,380	6,860	(25.8)
-1.5 m (-4.9 ft)	kg	*10,590	*10,590	*8,830	6,670	*6,710	4,440			*4,810	3,420	7.34
	lb	*23,350	*23,350	*19,470	14,700	*14,790	9,790			*10,600	7,540	(24.1)
-3.0 m (-9.8 ft)	kg			*6,690	6,690	*4,850	4,540					
	lb			*14,750	14,750	*10,690	10,010					

- Lifting capacity is based on ISO 10567.
- Lifting capacity of HX A Series does not exceed 75% of tipping load with the machine on firm, level ground or 87% of full hydraulic capacity.
- The Lift-point is bucket pivot mounting pin on the arm (without bucket mass).
- (\*) indicates load limited by hydraulic capacity.
- Caution: please be aware of the local regulations and instructions for lifting operations.

# BUCKET SELECTION GUIDE

## BUCKETS



SAE heaped m³ (yd³)	◆ 0.80 (1.05)	◆ 1.34 (1.75)	■ 0.90 (1.18)	● 0.87 (1.14)
	◆ 0.87 (1.14)		■ 1.05 (1.37)	
	◆ 0.92 (1.20)		■ 0.85 (1.11)	
	◆ 1.10 (1.44)		■ 1.00 (1.31)	
	◆ 1.20 (1.57)		■ 1.15 (1.50)	

Type	Capacity m³ (yd³)		Width mm (in)	Weight kg (lb)	Tooth (EA)	Recommendation mm (ft. in.)						
	SAE heaped	CECE heaped				5,650 (18' 6") Mono Boom			5,650 (2PCS) (18' 6") Mono Boom			
			Without side cutters			2,000 (6' 7") Arm	2,400 (7' 10") Arm	2,920 (9' 7") Arm	3,900 (12' 10") Arm	2,000 (6' 7") Arm	2,400 (7' 10") Arm	2,920 (9' 7") Arm
HX210AL	◆ 0.80 (1.05)	0.70 (0.92)	1,070 (42")	770 (1,700)	5	●	●	●	○	●	●	●
	◆ 0.87 (1.14)	0.76 (0.99)	1,140 (45")	804 (1,770)	5	●	●	●	○	●	●	●
	◆ 0.92 (1.20)	0.80 (1.05)	1,190 (47")	820 (1,810)	5	●	●	●	■	●	●	●
	◆ 1.10 (1.44)	0.96 (1.26)	1,375 (54")	890 (1,960)	5	●	○	■	▲	●	○	■
	◆ 1.20 (1.57)	1.05 (1.37)	1,390 (55")	920 (2,030)	5	○	○	■	▲	○	■	■
	◆ 1.34 (1.75)	1.17 (1.53)	1,525 (60")	990 (2,180)	6	○	■	▲	-	■	■	▲
	■ 0.90 (1.18)	0.79 (1.03)	1,210 (48")	880 (1,940)	5	●	●	●	■	●	●	○
	■ 1.05 (1.37)	0.92 (1.20)	1,355 (53")	940 (2,070)	5	●	●	○	▲	●	○	■
	■ 0.85 (1.11)	0.76 (0.99)	962 (38")	860 (1,900)	4	●	●	●	○	●	●	●
	■ 1.00 (1.31)	0.89 (1.16)	1,112 (44")	950 (2,090)	5	●	●	○	▲	●	●	○
● 0.87 (1.14)	0.77 (1.01)	1,195 (47")	940 (2,070)	5	●	○	■	▲	○	○	■	
HX210ANL	◆ 0.80 (1.05)	0.70 (0.92)	1,070 (42")	770 (1,700)	5	●	●	○	▲	●	●	●
	◆ 0.87 (1.14)	0.76 (0.99)	1,140 (45")	804 (1,770)	5	●	○	■	▲	●	●	○
	◆ 0.92 (1.20)	0.80 (1.05)	1,190 (47")	820 (1,810)	5	●	○	■	▲	●	○	■
	◆ 1.10 (1.44)	0.96 (1.26)	1,375 (54")	890 (1,960)	5	■	■	▲	▲	○	■	▲
	◆ 1.20 (1.57)	1.05 (1.37)	1,390 (55")	920 (2,030)	5	■	▲	▲	▲	■	■	▲
	◆ 1.34 (1.75)	1.17 (1.53)	1,525 (60")	990 (2,180)	6	▲	▲	▲	▲	■	▲	▲
	■ 0.90 (1.18)	0.79 (1.03)	1,210 (48")	880 (1,940)	5	●	○	■	▲	●	○	■
	■ 1.05 (1.37)	0.92 (1.20)	1,355 (53")	940 (2,070)	5	■	■	▲	▲	○	■	▲
	■ 0.85 (1.11)	0.76 (0.99)	962 (38")	860 (1,900)	4	●	○	■	▲	●	●	○
	■ 1.00 (1.31)	0.89 (1.16)	1,112 (44")	950 (2,090)	5	○	■	▲	▲	○	○	■
■ 1.15 (1.50)	1.01 (1.32)	1,262 (50")	1,030 (2,270)	6	■	▲	▲	▲	■	■	▲	
● 0.87 (1.14)	0.77 (1.01)	1,195 (47")	940 (2,070)	5	●	○	■	▲	●	●	○	

- ◆ General Purpose
- Heavy Duty
- Rock-HD
- Applicable for materials with density of 2,100 kgf/m³ (3,500 lbf/yd³) or less
- Applicable for materials with density of 1,800 kgf/m³ (3,000 lbf/yd³) or less
- Applicable for materials with density of 1,500 kgf/m³ (2,500 lbf/yd³) or less
- ▲ Applicable for materials with density of 1,200 kg/m³ (2,000 lb/yd³) or less
- X Not Recommended

# DIGGING FORCE

## ATTACHMENT

Booms and arms are welded with a low-stress, full-box section design.  
5.65 Mono & 5.65 2-Piece Booms and 2.0 m, 2.4 m, 2.92 m, 3.9 m Arms are available.

## DIGGING FORCE

Boom	Length	mm (ft. in.)	5,650 (18' 6")				Remarks:
	Weight	kg (lb)	1,950 (4,300)				
Arm	Length	mm (ft. in.)	2,000 (6' 7")	2,400 (7' 10")	2,920 (9' 7")	3,900 (12' 10")	[ ]: Power Boost
	Weight	kg (lb)	975 (2,150)	1,045 (2,300)	1,095 (2,410)	1,295 (2,850)	
Bucket digging force	SAE	kN	133.4 [144.8]	133.4 [144.8]	133.4 [144.8]	133.4 [144.8]	
		kgf	13,600 [14,770]	13,600 [14,770]	13,600 [14,770]	13,600 [14,770]	
		lbf	29,980 [32,560]	29,980 [32,560]	29,980 [32,560]	29,980 [32,560]	
	ISO	kN	152.0 [165.0]	152.0 [165.0]	152.0 [165.0]	152.0 [165.0]	
		kgf	15,500 [16,830]	15,500 [16,830]	15,500 [16,830]	15,500 [16,830]	
		lbf	34,170 [37,100]	34,170 [37,100]	34,170 [37,100]	34,170 [37,100]	
Arm crowd force	SAE	kN	144.2 [156.5]	119.6 [129.9]	102.0 [110.7]	84.3 [91.6]	
		kgf	14,700 [15,960]	12,200 [13,250]	10,400 [11,290]	8,600 [9,340]	
		lbf	32,410 [35,190]	26,900 [29,210]	22,930 [24,890]	18,960 [20,590]	
	ISO	kN	151.0 [164.0]	125.5 [136.3]	106.9 [116.0]	87.3 [94.7]	
		kgf	15,400 [16,720]	12,800 [13,900]	10,900 [11,830]	8,900 [9,660]	
		lbf	33,950 [36,860]	28,220 [30,640]	24,030 [26,080]	19,620 [21,300]	

Note : Boom weight includes arm cylinder, piping, and pin  
Arm weight includes bucket cylinder, linkage, and pin

# STANDARD/OPTIONAL EQUIPMENT

ENGINE	STD
Cummins B4.5	•

HYDRAULIC SYSTEM	STD
<b>Electric Pump Flow Control (EPFC)</b>	
3-power mode, 2-work mode, user mode	•
Variable power control	•
Pump flow control	•
Attachment mode flow control	•
Engine auto idle	•
Electronic swing parking brake	•
Engine auto shutdown control	•
Electronic fan control	•
Hyundai Bio Hydraulic Oil (HBHO)	•

CABIN & INTERIOR	STD
<b>ISO Standard cabin</b>	
Rise-up type windshield wiper	•
Radio / USB player	•
Handsfree mobile phone system with USB	•
12-volt power outlet (24V DC to 12V DC converter)	•
Electric horn	•
All-weather steel cab with 360° visibility	•
Safety glass - tempered glass	•
Safety glass - laminated glass, front window & glass	•
Sliding Fold-In Front Window	•
Sliding side window (LH)	•
Lockable door	•
Hot & cool box	•
Storage compartment	•
Ashtray & cigar lighter	•
Transparent cabin roof-cover	•
Sun visor	•
Door and cab locks, one key	•
Mechanical suspension seat with heater	•
Pilot-operated slidable joystick	•
Console box height adjust system	•
<b>Automatic climate control</b>	
Air conditioner & heater	•
Defroster	•
Starting aid (air grid heater) for cold weather	•
<b>Centralised monitoring</b>	
8" LCD display	•
Engine speed or trip meter / accel.	•
Engine coolant temperature gauge	•
Max. power	•
Low speed / high speed	•
Auto idle	•
Overload warning with alarm	•
Check engine	•
Air cleaner clogging	•
Indicators	•
ECO gauges	•
Fuel level gauge	•
Hyd. oil temperature gauge	•
Fuel warmer	•
Warnings	•
Communication error	•
Low battery	•
Clock	•
Cabin lights	•
Cabin front window rain guard	•
Cabin roof-steel cover	•
<b>Seat</b>	
Adjustable air suspension seat with heater	•
<b>Cabin FOG (ISO 10262) Level 2</b>	
FOG (Falling Object Protective Structure) - ISO 10262 Level 2	•
<b>Cabin ROPS</b>	
ROPS (Roll Over Protective Structures) - ISO 1211 7-2	•

SAFETY	STD
Lifting mode	•
Battery master switch	•
Rearview camera	•
AAVM (Advanced Around View Monitoring)	•
Four front working lights (2 boom mounted, 2 front frame mounted)	•
Travel alarm	•
Rear work lamp	•
Beacon lamp	•
Automatic swing brake	•
Boom holding system	•
Arm holding system	•
Safety valve for boom and arm cylinders with overload warning device	•
Safety valve for dozer blade cylinder	•
Swing lock system	•
Three outside rearview mirrors	•
Front guard - wire net	•

ATTACHMENT	STD
<b>Booms</b>	
5.65 m, 18' 6" Mono	•
5.65 m, 18' 6" 2-Piece	•
<b>Arms</b>	
2.0 m, 6' 7"	•
2.4 m, 7' 10"	•
2.92 m, 9' 7"	•
3.9 m, 12' 10"	•

OTHER	STD
Removable clean-out dust net for cooler	•
Removable reservoir tank	•
Fuel warmer	•
Fuel pre-filter	•
Self-diagnostics system	•
Hi-MATE (remote management system)	•
Batteries (2 × 12 V × 100 AH)	•
Fuel filler pump with auto stop (50 l/min)	•
Single-acting piping kit (breaker, etc.)	•
Double-acting piping kit (clamshell, etc.)	•
2 way proportional RCV & pedal control selection	•
Rotating piping kit	•
Quick coupler piping	•
Quick coupler	•
One pedal straight travel system	•
Accumulator for lowering work equipment	•
Pattern change valve (2 patterns)	•
Fine swing control system	•
Tool kit	•

UNDERCARRIAGE	STD
Lower frame under cover (additional)	•
Lower frame under cover (normal)	•
<b>Track shoes</b>	
Triple grousers shoes (500 mm, 20")	•
Triple grousers shoes (600 mm, 24")	•
Triple grousers shoes (700 mm, 28")	•
Triple grousers shoes (800 mm, 32")	•
Triple grousers shoes (900 mm, 35")	•
Double grousers shoes (700 mm, 28")	•
Track rail guard	•

\* Standard and optional equipment may vary. Contact your Hyundai dealer for more information. The machine may vary according to International standards.

\* The photos may include attachments and optional equipment that are not available in your area.

\* Materials and specifications are subject to change without advance notice.

\* All imperial measurements rounded off to the nearest pound or inch.





Specifications and design are subject to change without notice. Pictures of Hyundai Construction Equipment Europe products may show other than standard equipment.

Hyundai Construction Equipment Europe nv.  
Hyundailaan 4, 3980 Tessenderlo, Belgium.  
Tel: (+32) 14-56-2200 Fax: (+32) 14-59-3405

EN - 2021.01 Rev 2

**Ready to experience the Hyundai Effect?**

**Contact your Hyundai dealer.**  
[hyundai-ce.eu/en/dealer-locator](https://hyundai-ce.eu/en/dealer-locator)

