

WHEEL LOADER

HL970A





READY TO CHANGE YOUR WORLD

The HL970A Wheel Loader is part of Hyundai's A-Series: a fresh generation of construction equipment that complies with the European stage V emission levels. But it does much more than that! While fulfilling regulatory demands, Hyundai aimed for a ground-breaking level of customer satisfaction with maximum performance and productivity, better safety, more convenience and improved uptime management.

Featuring impressive power matched with carefully selected technologies that help you to work more efficiently and economically, this 24-tonne loader opens up a world of new possibilities. It's time to experience the Hyundai Effect!

ENTER A WORLD WHERE ANYTHING IS POSSIBLE



Productivity

- Load sensing hydraulic system
- Accurate weighing system
- Eco pedal (option)
- Eco Report
- Smart Power mode
- Hydraulic differential lock
- 5-speed transmission with lock-up clutch
- Intelligent clutch cut-off (ICCO)
- Automatic engine shutdown

Durability/Safety

- Unified control valve
- Enhanced axle capacity
- AAVM camera system (option)
- Radar rear detection (option)
- IMOD (Intelligent Moving Object Detection) (option)
- Premium quality axles
- Axle cooling (option)
- Thermostat-based transmission cooling
- Optimised drive shaft
- Completely sealed engine room
- High grade hoses
- Foldable side mirror
- Seat belt warning alarm

Comfort

- Spacious soundproofed cabin
- Wide touchscreen monitor
- Ride control system
- Fully adjustable seat and armrest
- Remote door control (option)
- Soft end stop

Serviceability

- ECD (Engine Connected Diagnostics)
- Fully openable engine hood
- Hi-MATE telematic system
- Easy filter replacement
- Auto greasing system (option)
- Wide core & fin radiator



“The seat, armrest and controls feel as if they were made to measure. It’s almost as if I’m part of the machine.”



The HL970A has a **large, comfortable, air suspended seat** with heating as standard. The seat and armrest are fully adjustable.



The cabin door can optionally be **opened remotely** for added safety and convenience.

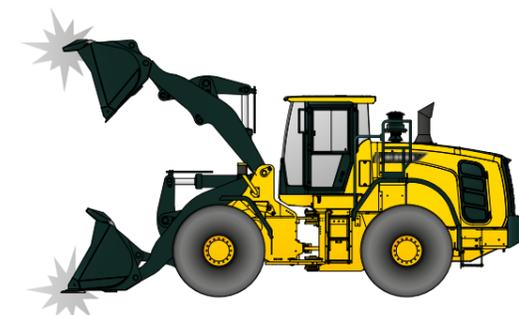

The **soft end stop** function reduces the hydraulic speed of the cylinder as it reaches the end of its stroke. This lessens the shock load of the stroke for increased operating comfort and better material retention.

A CABIN DESIGNED AROUND YOU

The HL970A cabin was designed to be a productive, stress-free working environment that fits every operator perfectly. Pleasant and spacious, it features state-of-the-art noise and vibration reduction technology, achieving a sound level of only 70 dB, one of the lowest in this machine category. The high-quality, adjustable seat provides comfortable reach to all controls. A range of technologies enable easier machine monitoring, while the audio system includes radio, USB and AUX input to keep you entertained during your working day.



The **Eco Report** feature makes it easy for operators to develop efficient working habits by displaying real-time information about machine performance.

The **instrument panel** is optimised to provide quick, easy access to machine status information as you work. It features a seven-inch **touchscreen monitor** for excellent legibility.

All the indicators displaying **machine status** are centralised in one cluster to enable easy, efficient control.



EXTRA PROTECTION FOR CO-WORKERS AND EQUIPMENT

Details can make a huge difference when it comes to safety, especially if you're working in rough conditions. It's not just a matter of complying with rules.

The HL970A's safety features are designed and tested to meet your needs in the real world, even offering an extra pair of eyes with the optional All-Around View Monitoring (AAVM) and radar systems. Operating confidence is improved by technologies that provide a feeling of stability and smooth performance in high-load work. By helping to ensure a calm, accident-free worksite, this wheel loader adds to the productivity and peace of mind that are all part of the Hyundai Effect.

"For such a tough-looking machine, its performance is surprisingly smooth and predictable. It gives me extra confidence and a feeling of safety in any conditions."

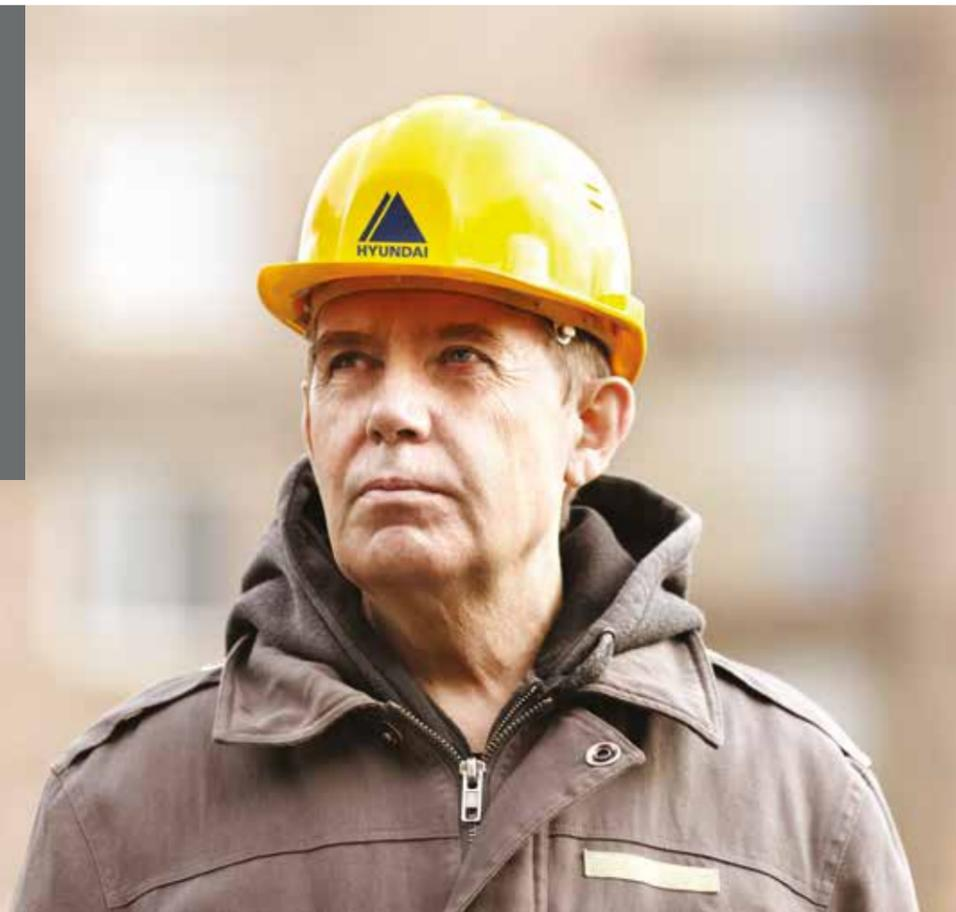

A **ride control system** with a piston accumulator reduces pitching of the wheel loader body and bucket for more stable and comfortable operation. It also minimises spillover, adding to convenience and productivity.

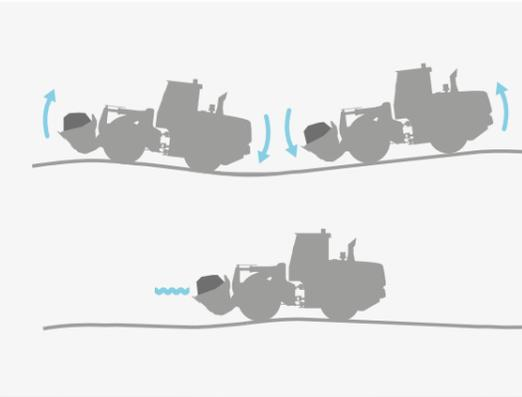

A **hydraulic locking differential** prevents tyre slip for more secure operation as well as better productivity and fuel economy.

The optional **Advanced Around View Monitoring (AAVM)** system gives you a 360° overview of your immediate working environment. It also includes Intelligent Moving Object Detection (IMOD) technology that senses and warns you when people or objects come within five metres of the machine.

The **side mirror** is easy to adjust for optimal visibility and can be folded away to prevent damage during transportation.



Operators are reminded to fasten their **safety belt** by an **audible and visible alarm**.

The optional **radar system** detects obstacles behind the machine day and night, with no blind spots. The distance between the obstacle and the loader is displayed on the monitor.

TAILORED TECHNOLOGIES TO BOOST YOUR PRODUCTIVITY

The HL970A's reliable Cummins L9 Stage V engine delivers immense power to handle heavy-duty work in extreme conditions. It is complemented by a range of technologies that enhance fuel efficiency while keeping harmful emissions to a minimum.

Precise operating systems help you to get the most out of this mighty machine, including optimised power matching for the ultimate balance of

torque and RPM. When operated in Power Smart mode, the engine delivers fuel savings of up to 5% as well as smooth performance in high-load work such as digging. Hyundai's proprietary weighing system technology is integrated as standard. Additional control, monitoring and maintenance features help you to optimise performance and productivity every single day, on any worksite.



Like all A-Series machines, the HL 970A features our **all-in-one exhaust aftertreatment system** which cuts emissions and operating costs while enhancing reliability and simplifying maintenance.



The highly accurate **automatic/manual cumulative weighing system** helps you to manage production more efficiently in any environment. For maximum precision, weighing error icons and a two-colour weight value indicator are displayed on the monitor.



The new **Smart Power mode** adjusts engine RPM in heavy load work like digging to save fuel without compromising on performance. The technology also achieves an optimal balance between traction and breakout forces.



The **engine shuts down automatically when the machine is at rest** to cut fuel consumption and prevent unnecessary emissions. Different operating modes and idling times can be selected according to the work environment, further enhancing efficiency.

"It's easy on fuel and it certainly doesn't compromise on power or performance."



The HL970A is equipped with a **five-speed transmission and a lockup clutch**, allowing you to work more efficiently while keeping fuel consumption and emissions low.



MORE UPTIME FOR A RELIABLE RETURN ON YOUR INVESTMENT



To protect your business, you need to know that the investment you make today will sustain your profits over the long term. That's why we prioritised reliability throughout the development of the HL970A, from design and manufacturing to quality control. The axles,

driveshaft and all operating systems have been optimised for endurance and tested rigorously on a range of work sites. The result is a tough, durable workhorse that minimises downtime for repairs and maintenance and helps you to protect your profits.

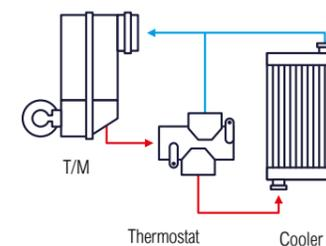

The HL970A is equipped with a **thermostat for transmission cooling**. This feature helps to warm up the fluid quickly and keeps it at the optimal working temperature, protecting components and increasing efficiency.

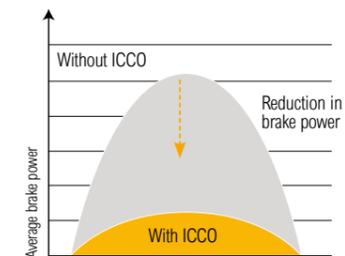

The **Intelligent Clutch Cut-Off (ICCO)** function minimises loss of power in the torque converter and prevents excessive power use during braking. This reduces heat generation and wear on the brake disc.



The hydraulic system has been simplified with a **unified control valve system**. This removes the need for hydraulic hoses connected to each valve, decreasing the number of possible leak points.

High-grade hoses with outstanding resistance to heat and pressure provide maximum durability, even in rough working conditions.

The HL970A features **premium quality axles with enhanced load capacity** for better reliability and durability. A separate **axle oil cooling system** is available as an option to prevent overheating during high-load work or tasks requiring frequent braking.

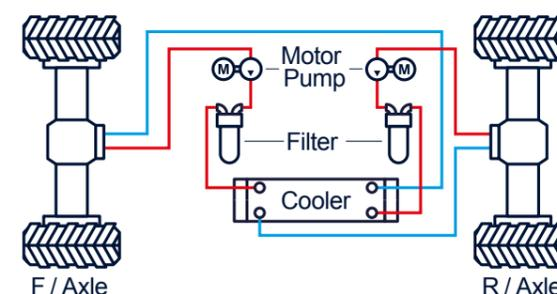

EASY SERVICING FOR TROUBLE-FREE OWNERSHIP

The peace of mind that comes with quick, low-effort servicing is part of what we call the Hyundai Effect. The HL970A is designed to make maintenance as convenient as possible. The engine hood opens wide to provide easy access for cleaning and routine tasks. All components and materials have been optimised to ensure a long, trouble-free life.

Hyundai's Hi-MATE remote management system can be integrated as an option to provide the highest level of service and support. The HL970A also features our new Engine Connected Diagnostics (ECD) system which immediately reports any engine failure to both Hi-MATE and the engine manufacturer to ensure the fastest, easiest resolution.

HiMATE

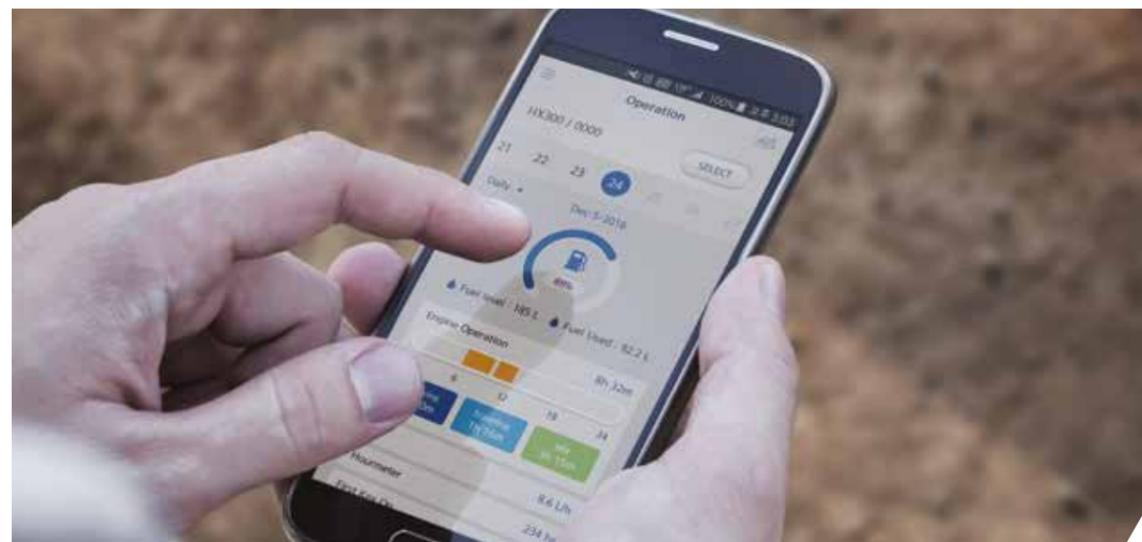

Hyundai's exclusive Hi-MATE remote management system allows you to monitor your machines from any location via a dedicated website or mobile app, with access to diagnostics and working parameters like total engine hours, actual working hours and fuel consumption. The system makes it easy to evaluate machine productivity and plan servicing and maintenance tasks, as well as any required cost saving measures. It also offers geofencing to protect your machines against theft and unauthorised usage.

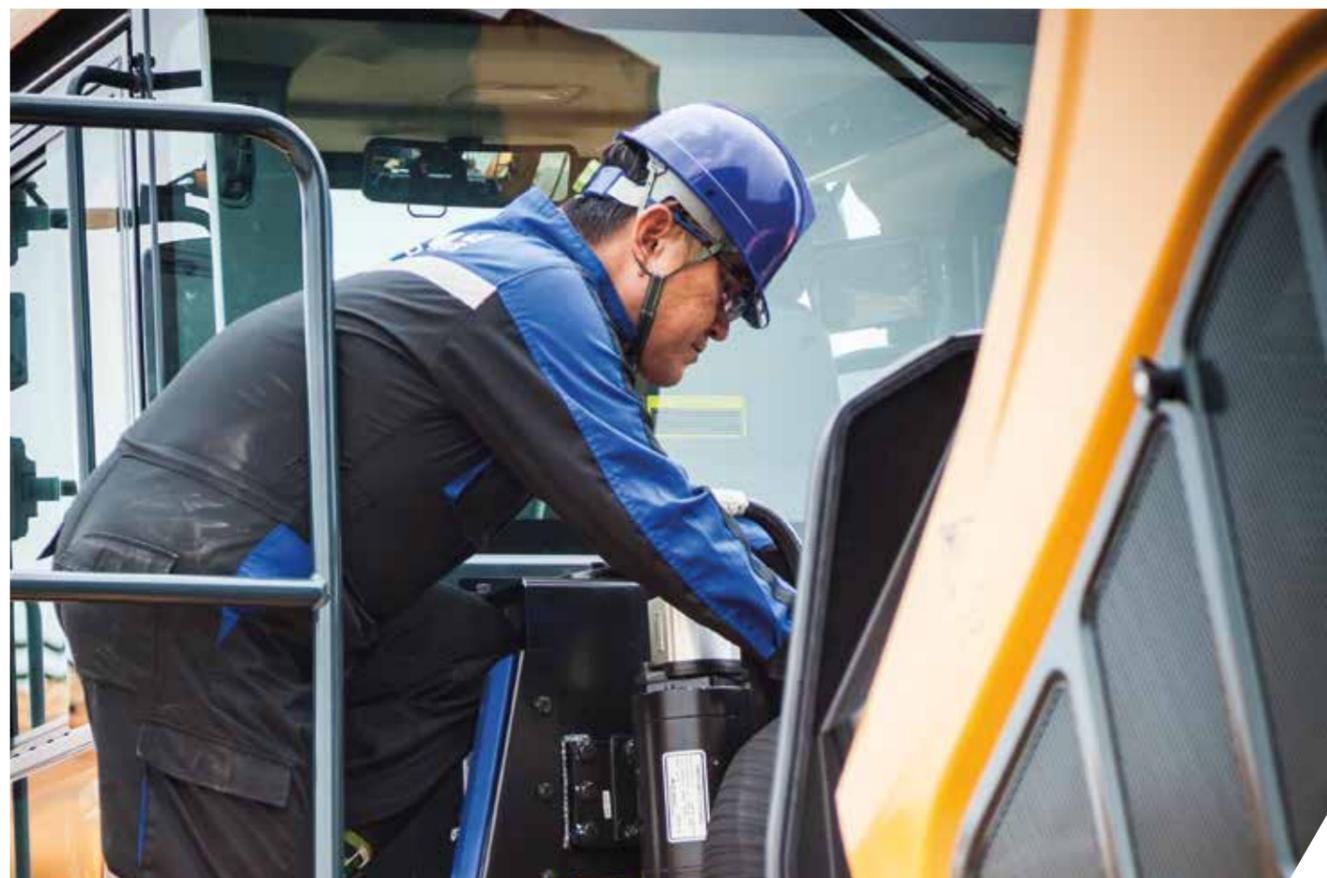

Our new **Engine Connected Diagnostics (ECD)** technology supports service technicians by providing remote diagnostics reports so that they can prepare properly for site visits.



With the optional **auto greasing system**, grease is applied to lubrication points automatically when needed. The correct dosing is ensured and lubricant is applied uniformly, reducing grease consumption and eliminating waste.



The **tilt-back engine hood is fully retractable** and can be **opened electrically** for easy access to the sealed engine room and cooling room. The engine room is designed to prevent the possibility of fire caused by the inflow of foreign materials.



The **air conditioning filter** is easy to replace and is made from a specially selected material for superior performance.



The HL970A has a dependable **wide-core and fin air cooler** that prevents performance degradation caused by contamination.

FOCUSED TECHNOLOGIES FOR THE RESULTS YOU WANT

Hyundai's A-Series wheel loaders are designed to create better conditions for operators and deliver the ultimate ownership experience. Every detail is carefully fine-tuned to match your needs in the field, including better safety and comfort, higher productivity, maximum uptime and easy servicing. This is all part of the Hyundai Effect.

See more at hyundai-ce.eu

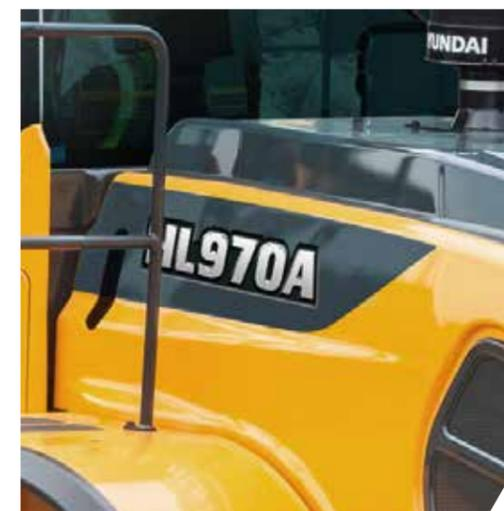

DIMENSIONS

DIMENSIONS

All dimensions are approximate.

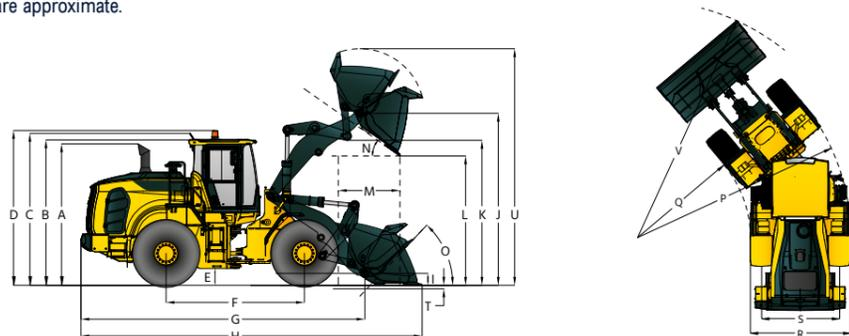

Description	HL970A		HL970AXT	
	mm	ft in	mm	ft in
A Height to Top of Exhaust Pipe	3,570	11' 9"	3,570	11' 9"
B Height to Top of Cabin	3,590	11' 9"	3,590	11' 9"
C Height to Top of Product Link Antenna	3,665	12' 0"	3,665	12' 0"
D Height to Top of Warning Beacon	3,720	12' 2"	3,720	12' 2"
E Ground Clearance	480	1' 7"	480	1' 7"
F Wheelbase	3,500	11' 6"	3,500	11' 6"
G Overall Length (Without Bucket)	7,395	24' 3"	7,935	26' 0"
H Shipping Length (With Bucket Level on Ground)	8,740	28' 8"	9,280	30' 5"
I Hinge Pin Height at Carry Position	500	1' 8"	615	2' 0"
J Hinge Pin Height at Maximum Lift	4,325	14' 2"	4,815	15' 10"
K Lift Arm Clearance at Maximum Lift	3,605	11' 10"	4,095	13' 5"
L Dump Clearance at Maximum Lift and 45° Discharge	3,080	10' 1"	3,570	11' 9"
M Reach at Maximum Lift and 45° Discharge	1,270	4' 2"	1,255	4' 1"
N Dump Angle at Maximum Lift and Dump (on Stops)	50			
O Roll Back Angle	Ground	43		
	Carry	47		49
P Clearance Circle (Diameter) to Outside of Tyres	12,885	42' 3"	12,885	42' 3"
Q Clearance Circle (Diameter) to Inside of Tyres	6,800	22' 4"	6,800	22' 4"
R Width Over Tyres (Unloaded)	2,980	9' 9"	2,980	9' 9"
S Tread Width	2,300	7' 7"	2,300	7' 7"

OPERATING SPECIFICATIONS WITH BUCKETS

Linkage Bucket Type	Edge Type	General Purpose Pin On			General Purpose Hook On	High Lift Linkage Change
		Bolt-On Cutting Edges	Bolt-On Cutting Edges	Bolt-On Cutting Edges	Bolt-On Cutting Edges	
Capacity - Rated	m³	4.20	5.20	4.50	4.20	-
	yd³	5.50	6.80	5.90	5.50	
Capacity - Rated at 110% Fill Factor	m³	4.62	5.72	5.90	4.62	-
	yd³	6.00	7.50	4.95	6.00	
Width	mm	3,100	3,250	3,100	3,100	-
	ft/in	10' 2"	10' 8"	10' 2"	10' 2"	
Dump Clearance at Maximum Lift & 45° Discharge	mm	3,080	2,975	3,040	2,865	+490
	ft/in	10' 1"	9' 9"	9' 12"	9' 5"	+1' 7"
Reach at Maximum Lift & 45° Discharge	mm	1,270	1,375	1,310	1,485	-15
	ft/in	4' 2"	4' 6"	4' 4"	4' 10"	-0.6"
Digging Depth	mm	100	100	100	100	+15
	ft/in	0' 4"	0' 4"	0' 4"	0' 4"	+0.6"
Shipping Length (with Bucket)	mm	8,740	8,890	8,800	9,045	+540
	ft/in	28' 8"	29' 2"	28' 10"	29' 8"	+1' 9"
Overall Height with Bucket at Maximum Lift	mm	5,970	6,120	6,030	6,185	+490
	ft/in	19' 7"	20' 1"	19' 9"	20' 4"	+1' 7"
Loader Clearance Circle with Bucket at Carry Position	mm	14,310	14,540	14,350	14,500	+400
	ft/in	46' 11"	47' 8"	47' 1"	47' 7"	+1' 4"
Static Tipping Load. Straight (No Tyre Deflection)	kg	18,350	17,900	18,300	16,500	-2,100
	lb	40,455	39,465	40,345	36,380	-4,625
Static Tipping Load. Articulated (No Tyre Deflection)	kg	15,850	15,500	15,800	14,250	-1,900
	lb	34,945	34,175	34,835	31,420	-4,185
Breakout Force	kg	21,715	19,540	20,785	17,700	+60
	lb	47,875	43,080	45,825	39,025	+135
Operating Weight*	kg	24,200	24,475	24,255	24,840	+800
	lb	53,355	53,960	53,475	54,765	+1,765

* All height and tyre related dimensions are with standard 23.5 R25, L3 tyres.

DENSITY AND BUCKET SELECTION

DENSITY OF OPERATING MATERIALS

Loose Material	Material Density [ton / m³]	
Earth / Clay	1.5 ~ 1.7	
Sand and Gravel	1.5 ~ 1.7	
Aggregate	25 ~ 76 mm (1 to 3 in)	1.6 ~ 1.7
	19 mm (3 in) and larger	1.8

HL970A BUCKET SELECTION CHART

Standard Lift Arm - General Purpose Bucket																
Type	m³ (yd³)	Material Density [ton / m³]														
		0.8 (1349)	0.9 (1517)	1.0 (1686)	1.1 (1854)	1.2 (2023)	1.3 (2191)	1.4 (2360)	1.5 (2528)	1.6 (2697)	1.7 (2865)	1.8 (3034)	1.9 (3203)	2.0 (3371)	2.1 (3540)	2.2 (3708)
Cutting edge	4.2 (5.49)	4.8 m³ (6.28 yd³)											4.0 m³ (5.23 yd³)			
Cutting edge	5.2 (6.8)	6.0 m³ (7.85 yd³)											4.9 m³ (6.41 yd³)			
Cutting edge	4.5 (5.89)	5.2 m³ (6.8 yd³)											4.3 m³ (5.62 yd³)			
Cutting Edge Q/C	4.2 (5.49)	5.8 m³ (7.59 yd³)											4.0 m³ (5.23 yd³)			

High lift arm (XT) - General Purpose Bucket																
Type	m³ (yd³)	Material Density [ton / m³]														
		0.8 (1349)	0.9 (1517)	1.0 (1686)	1.1 (1854)	1.2 (2023)	1.3 (2191)	1.4 (2360)	1.5 (2528)	1.6 (2697)	1.7 (2865)	1.8 (3034)	1.9 (3203)	2.0 (3371)	2.1 (3540)	2.2 (3708)
Cutting edge	4.2 (5.49)	4.8 m³ (6.28 yd³)											4.0 m³ (5.23 yd³)			
Cutting edge	5.2 (6.8)	6.0 m³ (7.85 yd³)											4.9 m³ (6.41 yd³)			
Cutting edge	4.5 (5.89)	5.2 m³ (6.8 yd³)											4.3 m³ (5.62 yd³)			
Cutting Edge Q/C	4.2 (5.49)	4.8 m³ (6.28 yd³)											4.0 m³ (5.23 yd³)			



CHANGE IN OPERATING SPECIFICATIONS - TYRES

Tyres		26.5-25, 20PR L5	26.5 R25 XHA	26.5-25 20PR L3
Operating Weight	kg	+520	-230	-340
	lb	+1,150	-505	-745
Static Tipping Load. Straight (No Tyre Deflection)	kg	+350	-160	-235
	lb	+775	-350	-515
Static Tipping Load. Articulated (No Tyre Deflection)	kg	+300	-135	-200
	lb	+665	-295	-440
Vertical Height Changes	mm	+58	-9	+20
	ft/in	+0.2"	-1.12"	+0.1"
R. Width Over Tyres (Unloaded)	mm	+13	-3	+11
	ft/in	+0.1"	-1.12"	+0.0"
P. Clearance Circle (Diameter) to Outside of Tyres	mm	+13	-3	+11
	ft/in	+0.1"	-0.0"	+0.0"
Q. Clearance Circle (Diameter) to Inside of Tyres	mm	-13	+3	-11
	ft/in	-0.1"	+0.0"	-0.0"

* Dimension changes compared to 26.5R25, * *, L3 radial tyres.

SPECIFICATIONS

ENGINE	
Maker / Model	CUMMINS L9 / EU Stage V
Type	6 Cylinder, Watercooled, 4-Cycle, Turbocharged Charge aircooled, Direct Injection, Electronic Controlled Diesel Engine.
Gross Power (SAE J1995)	325 HP (242 kW) at 2,100 rpm
Net Power (SAE J1349)	322 HP (240 kW) at 2,100 rpm
Max. Power	330 HP (264 kW) at 2,000 rpm
Peak Gross Torque (SAE J1995)	1636 N m (1,207 lb ft) at 1,100 rpm
Displacement	8.9 l (543 cu in)
Aftertreatment System	DOC, DPF, SCR, Waste Gate Turbo

- The indicated net power is available for the flywheel when the engine is equipped with a fan, alternator, air cleaner, and after-treatment device.
- The indicated gross power is obtained with the fan at maximum speed.

TRANSMISSION					
Torque converter type*	3-Elements, Single-stage, Single phase				
Tyre	26.5R25 L3				
Travel speed	4 speed T/M		5 speed T/M with lock up clutch		
	km/h	mph	km/h	mph	
Forward	1st	7.3	4.5	7.3	4.5
	2nd	12.3	7.6	12.5	7.8
	3rd	27.4	17.0	19.9	12.4
	4th	40.0	24.9	28.4	17.7
	5th		-	40.0	24.9
Reverse	1st	7.3	4.5	7.3	4.5
	2nd	12.3	7.6	12.5	7.8
	3rd	27.4	17.0	28.4	17.7

- * Full automatic power shift, countershaft type with soft-shift in range and direction. Properly matched torque converter to engine and transmission for excellent working ability

AXLES	
Drive system	Four-wheel drive system
Mount	Fixed
Rear axle oscillation	Oscillating ±11 degrees
Hub reduction	Planetary reduction at wheel end
Differential	Conventional
Reduction ratio	24.667

OVERVIEW			
Description	HL970A	HL970A XT	
Operating weight	24,200 kg (53,355 lb)	25,000 kg (55,120 lb)	
Bucket capacity	Heaped	4.20 m³ (5.50 yd³)	4.20 m³ (5.50 yd³)
	Struck	3.60 m³ (4.70 yd³)	3.60 m³ (4.70 yd³)
Breakout force-bucket	21,715 kg (47,875 lb)	21,775 kg (48,010 lb)	
Tipping load	Straight	18,350 kg (40,455 lb)	16,250 kg (35,830 lb)
	Full turn	15,850 kg (34,945 lb)	13,950 kg (30,755 lb)

TYRES	
Type	Tubeless, loader design tyres
Standard	26.5 R25 L3
Options include	26.5-25, 20PR L5
	26.5 R25 XHA
	26.5-25 20PR L3

BRAKES	
Service Brakes	Hydraulically actuated, wet disc brakes actuate all 4 wheels independent axle-by-axle system. Self adjusting & wheel speed brake.
Parking Brake	Spring-applied, hydraulically released brake
Emergency Brake	When brake oil pressure drops, indicator light alerts operator and parking brake automatically applies.

HYDRAULIC SYSTEM		
Type	Load sensing hydraulic system	
Pump	Variable displacement piston pump 359 lpm	
Control valve	2 spool (Bucket, Boom) 3 spool (Bucket, Boom, Aux)	
System pressure	280 bar (4,061 psi)	
Lift Circuit	The valve has four functions: raise, hold, lower and float. Can adjust automatic kickout from horizontal to full lift.	
Tilt Circuit	The valve has three functions: tilt back, hold and dump. Can adjust automatic bucket positioner to desired load angle.	
Cylinder	Type: double acting	
	No. of cylinders-bore x stroke;	
	Lift	mm 2-165 × 780 in 2-6.5 × 2'6.7
	HL970A Tilt	mm 1-180 × 565 in 1-7.1 × 1'10
	HL970AXT Tilt	mm 1-180 × 570 in 1-7.1 × 1'10
Hydraulic Cycle Time with Rated Payload	Raise from Carry Position: 6.0 Sec. Dump, at maximum raise: 1.5 Sec. Lower, empty, float down: 4.3 Sec. Total: 11.8 Sec.	

STEERING SYSTEM		
Type	Load sensing hydrostatic articulated steering	
Pump	Variable displacement piston pump	
System pressure	210 bar (3,046 psi)	
Cylinder	Double acting	2-95 × 468 mm (3.5' × 18.4')
Steering angle	40° to both right and left angle, respectively	
Features	Center-point frame articulation. Tilt and telescopic steering column.	

SERVICE REFILL CAPACITIES		
UNIT	l	US gal
Fuel tank	365	96.4
DEF tank	44.5	11.8
Cooling system	47	12.4
Crankcase	22.7	6.0
Transmission	53	14
Front axle	42	11.1
Rear axle	42	11.1
Hydraulic tank	152	40.2
Hydraulic system (Including tank)	276	72.9

AIR CONDITIONING SYSTEM	
The air conditioning system of this machine contains fluorinated greenhouse gas refrigerant R134a (GWP = 1430). The system contains 0.75 kg of refrigerant (1.07 metric tonne CO2 equivalent). For more information, Please refer to the manual.	

SOUND	
Guaranteed noise level presented below can be differed depending on a range of factors such as operating condition, speed of a cooling fan, types of engine and so forth. Hearing protection shall be necessary if an operator is working in the improperly maintained cabin or exposed to a noisy environment by leaving doors and/or windows open.	
With Cooling Fan Speed at Maximum Value:	
Operator Sound Pressure Level (ISO 6396:2008)	70 dB(A)
Exterior Sound Power Level (ISO 6395:2008)	107 dB(A)

- * Distance of 15 m (49.2 ft), moving forward in second gear ratio.

CABIN & INTERIOR		STD
ALARMS, AUDIBLE AND VISUAL		
Emergency Warning Lamp		•
Engine Coolant Temperature		•
Transmission Oil Temperature		•
Hydraulic Oil Temperature		•
Fuel Level		•
Transmission Error		•
Air Filter Clogging		•
Engine Oil Pressure		•
Battery Voltage		•
Brake Oil Pressure		•
Engine Stop		•
Engine Coolant Level		•
BATTERIES		
925 CCA, 12 V, 2 pcs		•
GAUGES		
Engine Coolant Temperature		•
Fuel Level		•
Transmission Oil Temperature		•
Speedometer		•
INDICATOR LIGHTS		
Parking Brake		•
High Beam		•
Joystick Steering		•
FNR		•
Differential Lock		•
Pilot Cut Off		•
Turning Light		•
Seat Belt ON/OFF		•
Engine Auto Stop		•
Clutch Cut Off		•
Ride Control		•
LCD DISPLAY		
DEF Level		•
DEF low Level		•
Transmission Gear Range		•
Clock and Fault Code		•
Job Time and Distance		•
Operating Hour Counter		•
Engine rpm		•
Horn, Electric		•
LIGHTING SYSTEM		
LED Dome Light		•
2 Stop and Tail Lights		•
4 Turn Signals		•
Brake Lights (Counterweight)		•
2 LED Rear Combi Lamp		•
2 Head Lights on Front Tower		•
2 LED Head Light		•
2 Working Lights on Front Roof		•
4 Working Lights on Front Roof		•
2 Working Lights on Rear Roof		•
4 Working Lights (LED) on Front Roof		•
2 Working Lights (LED) on Rear Roof		•
2 Working Lights on Grill		•
2 Working Lights (LED) on Grill		•
SWITCHES		
Hazard		•
DPF		•
Engine Hood Open		•
Parking		•
Battery Master Switch		•
FNR Shifter		•
Differential Lock Foot Switch		•
Emergency Steering		•
Pilot Cut Off		•
Air Compressor		•
IGNITION		
Key		•
Button		•
MEMBRANE SWITCHES IN MONITOR		
Main Light		•
Work Light		•
Auto Grease		•
Quick Coupler		•
Ride Control		•
Weighing System		•
Beacon Light		•
Rear Wiper		•
Mirror Heat		•
Auto Position		•
Fine Modulation		•
Cam		•

CABIN & INTERIOR		STD
CABIN (SOUND SUPPRESSED)		
ROPS/ FOPS Cabin		•
Cigar Lighter & Ashtray		•
Coat Hook		•
Rear View Mirrors (1 Inside)		•
Rear View Mirrors (2 Outside, Heated)		•
Steering Column, Tilt and Telescopic		•
Steering Wheel with Knob		•
Roller Type Sunshade (Front Window)		•
Roller Type Sunshade (Rear Window)		•
Tinted Safety Glass		•
One Door Cabin		•
Magazine Pocket		•
Radio / USB Player		•
Rubber Floor Mat		•
Wrist Rest		•
24 V to 12 V DC Converter (20 A)		•
DOOR		
Door and Cabin Locks, One Key		•
Doors, Service Access (Locking)		•
Doors, Service Access		•
Remote cabin door		•
AUTOMATIC CLIMATE CONTROL		
Air Conditioner and Heater		•
Defroster		•
Intermittent Wiper and Washer, Front and Rear		•
SEAT		
2" Retractable Seat Belt & Adjustable Mechanical Suspension (Heated)		•
2" Retractable Seat Belt & Adjustable Air Suspension (Heated)		•
PERSONAL STORAGE SPACE		
Console Box		•
Holder, Can and Cup		•
PEDALS		
One Accelerator Pedal		•
One Brake Pedal		•
Dual-Brake Pedal		•
Accel Pedal Without ECO Switch		•
Accel Pedal With ECO Switch		•

ENGINE		STD
Alternator, 95A		•
Antifreeze		•
Fuel Warmer		•
Fan Guard		•
Rain Cap, Engine Air Intake		•
Coolant Level Sight Gauge		•
Centrifugal Air Precleaner		•
Radiator		•
ENGINE, CUMMINS, L9		
EU STAGE V / EPA TIER 4 FINAL		•
Engine Fuel Priming Pump		•
Fuel / Water Separator		•
Engine Oil Level Dipstick Gauge		•
CLEAN EMISSION MODULE		
DOC, SCR and DPF		•

POWER TRAIN		STD
Torque Converter		•
Axle Cooling System		•
TRANSMISSION		
Transmission F4 / R3, Computer Controlled, Electronic Soft Shift, Auto-Shift And Kick-Down Features Included		•
Transmission F5 / R3 with lock-up clutch & Thermostat		•
Transmission Oil Sight Level		•
BRAKE		
Service Brake (Enclosed Wet-Disc)		•
Parking Brake		•
FRONT AXLE		
Hydraulic Lock Differential		•
Limited Slip Differential		•
Open Differential		•
REAR AXLE		
Limited Slip Differential		•
Open Differential		•
TYRES		
26.5R25 L3		•
26.5-25, 20PR L5		•
26.5R25 XHA		•
26.5-25 20PR L3		•
Travel speed limiter (20-40 km/h)		•

SAFETY		STD
Fire Extinguisher		•
Boom Safety Bar		•
Emergency Steering		•
OBJECT DETECTION		
IMOD (Intelligent Moving Object Detection)		•
AAVM (AVM + IMOD)		•
Secondary Monitor		•
Radar		•

HYDRAULIC SYSTEM		STD
Boom Kickout, automatic		•
Bucket Positioner, Automatic		•
Diagnostic Pressure Taps		•
Hydraulic Oil Cooler		•
EH Control (Joystick)		•
EH Control (Fingertip)		•
EH Joystick Steering		•
Ride Control System		•
Secondary Steering System		•
Extra Piping-for Auxiliary Function		•
Quick Coupler Piping		•
Auto Greasing		•
Hyundai Bio Hydraulic Oil (HBHO)		•
MCV 2 circuits		•
MCV 3 circuits		•

TELEMATICS		STD
Hi-MATE		•
ECD (Engine connected Diagnostics)		•

OTHER		STD
Articulation Locking Bar		•
Lift and tie-Down Hooks		•
Loader Linkage, Sealed		•
Z-bar Design		•
Long Boom		•
Vandalism Protection Caplocks		•
Tool Kit		•
COUNTERWEIGHT		
Counterweight		•
Counterweight - Heavy Weight		•
Drawbar with Pin		•
ERGONOMICALLY LOCATED AND SLIP RESISTANT, LEFT & RIGHT		
Handrails		•
Ladders		•
Platforms		•
Steps		•

BUCKET	
4.2m³ Bucket, Cutting Edge	
4.0m³ Bucket 1-Bolt-on Tooth Type	
4.0m³ Bucket 2-Bolt-on Tooth Type	
4.2m³ Bucket 2-Bolt-on Tooth & Segment Edge Type	
5.2m³ Bucket, Cutting Edge	
5.0m³ Bucket 1-Bolt-on Tooth Type	
5.0m³ Bucket 2-Bolt-on Tooth Type	
4.5m³ Bucket, Cutting Edge	
3.7m³ Bucket Spade Nose Rock Type	
4.2m³ Bucket, Cutting Edge Q/C Type	
ISO type Quick Coupler	
GUARDS	
Crankcase	
Transmission	
Fenders (Front / Rear)	•
Cabin Glass (Front / Rear)	•
Mud Guard	•

- * Standard and optional equipment may vary. Contact your Hyundai dealer for more information. The machine may vary according to International standards.
- * The photos may include attachments and optional equipment that are not available in your area.
- * Materials and specifications are subject to change without advance notice.
- * All imperial measurements rounded off to the nearest pound or inch.

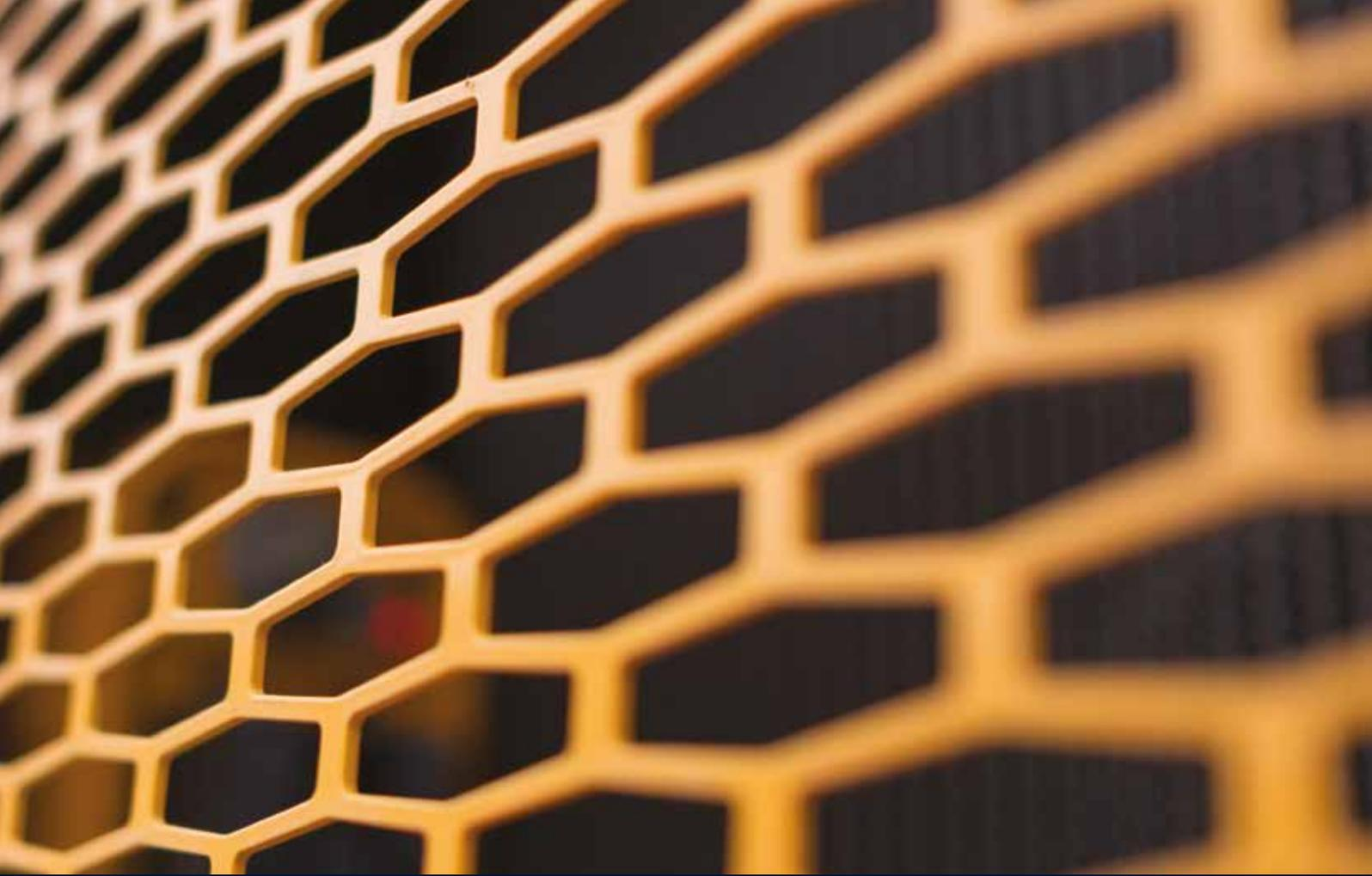

Specifications and design are subject to change without notice. Pictures of Hyundai Construction Equipment Europe products may show other than standard equipment.

Hyundai Construction Equipment Europe nv, Hyundailaan 4, 3980 Tessenderlo, Belgium. Tel: (32) 14-56-2200 Fax: (32) 14-59-3405

EN – 2020.02 Rev 1

Ready to experience the Hyundai Effect?

Contact your Hyundai dealer.
hyundai-ce.eu/en/dealer-locator

